

KECE321 Communication Systems I

(Haykin Secs. 3.7 - 3.8)

Lecture #11, April 18, 2012

Prof. Young-Chai Ko

Summary

- **Amplitude modulation**
 - Vestigial sideband (VSB) modulation
 - VSB modulation
 - VSB demodulation
 - Baseband representation of the modulated signal
 - Superheterodyne receiver
 - Frequency division multiplexing

Vestigial Sideband (VSB) Modulation

- VSB Modulation
 - Modulation to overcome the two difficulties of the SSB modulations.
 - Allow a small amount, or vestige, of the unwanted sideband to appear at the output of an SSB modulator
 - The design of the sideband filter is simplified since the need for sharp cutoff at the carrier frequency is eliminated.
 - In addition, a VSB system has improved low-frequency response and can even have dc response.

Idea of VSB Modulator

- Pass-band (or High-pass) filter for USB-SSB modulation

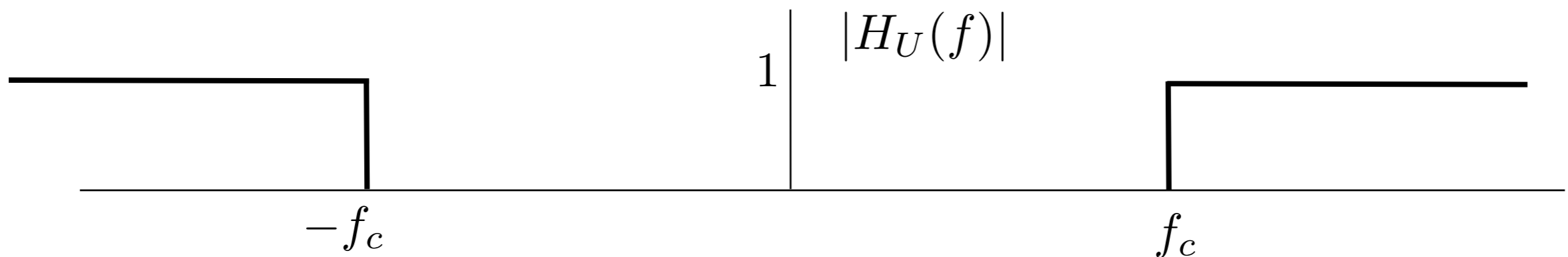

- The filter below is much easier to design and implement

VSB filter $H(f)$

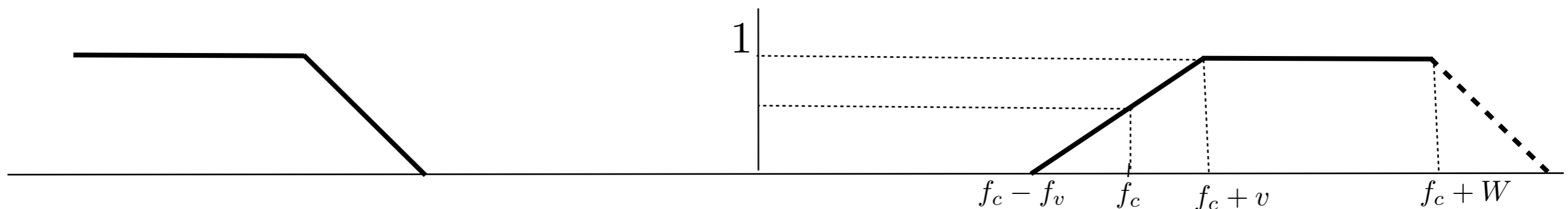

Note $H(f + f_c) + H(f - f_c) = 1$ for $-W \leq f \leq W$

■ Transmitter of VSB modulation

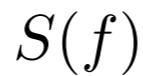
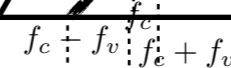
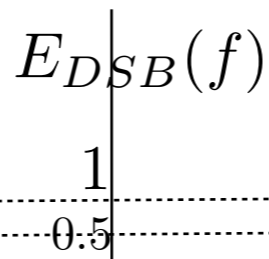
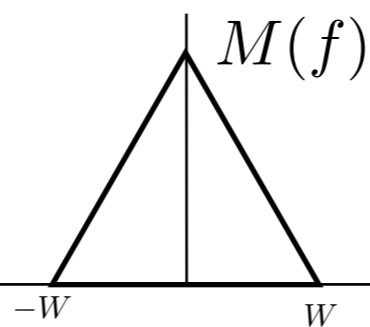
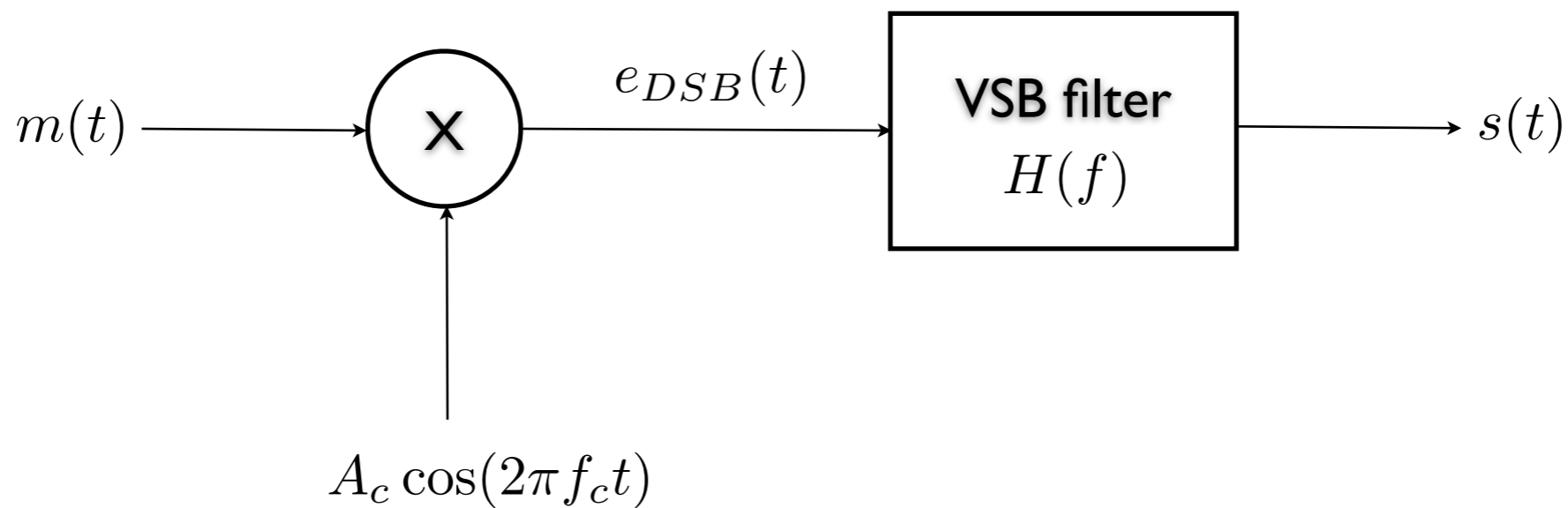

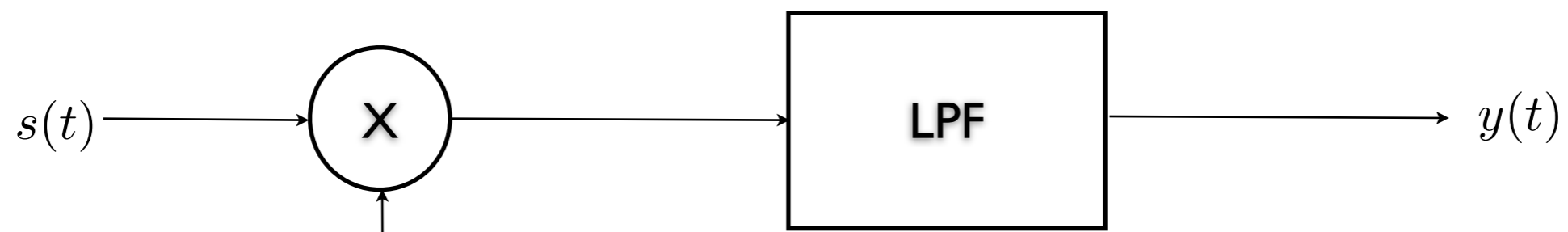
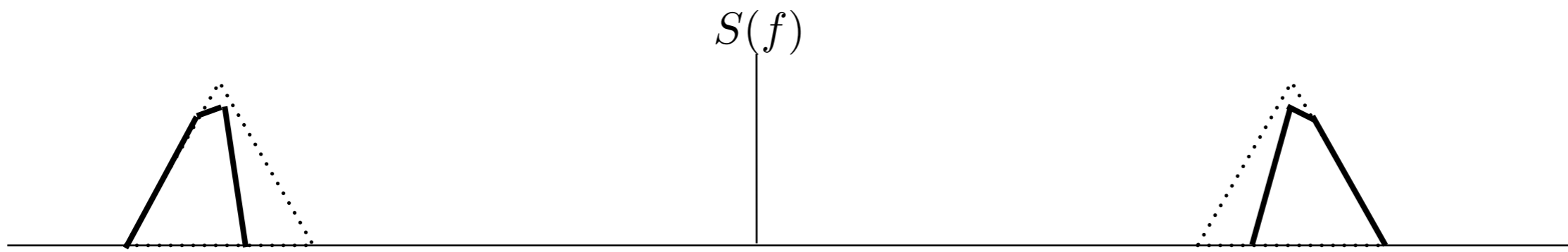

$$\cos(2\pi f_c t)$$

$$Y(f)$$

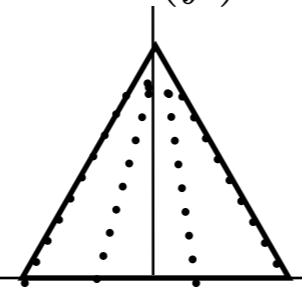

- Consider the two-tone message signal given as

$$m(t) = A \cos(2\pi f_1 t) + B \cos(2\pi f_2 t)$$

- Assume

$$0 < f_1 < f_v < f_2$$

- Message signal multiplied by the carrier wave, that is, DSB signal

$$\begin{aligned} e_{DSB}(t) &= (A \cos(2\pi f_1 t) + B \cos(2\pi f_2 t)) \cdot \cos(2\pi f_c t) \\ &= \frac{1}{2} A \cos(2\pi(f_c + f_1)t) + \frac{1}{2} A \cos(2\pi(f_c - f_1)t) \\ &\quad + \frac{1}{2} B \cos(2\pi(f_c + f_2)t) + \frac{1}{2} B \cos(2\pi(f_c - f_2)t) \end{aligned}$$

- Spectrum of DSB signal

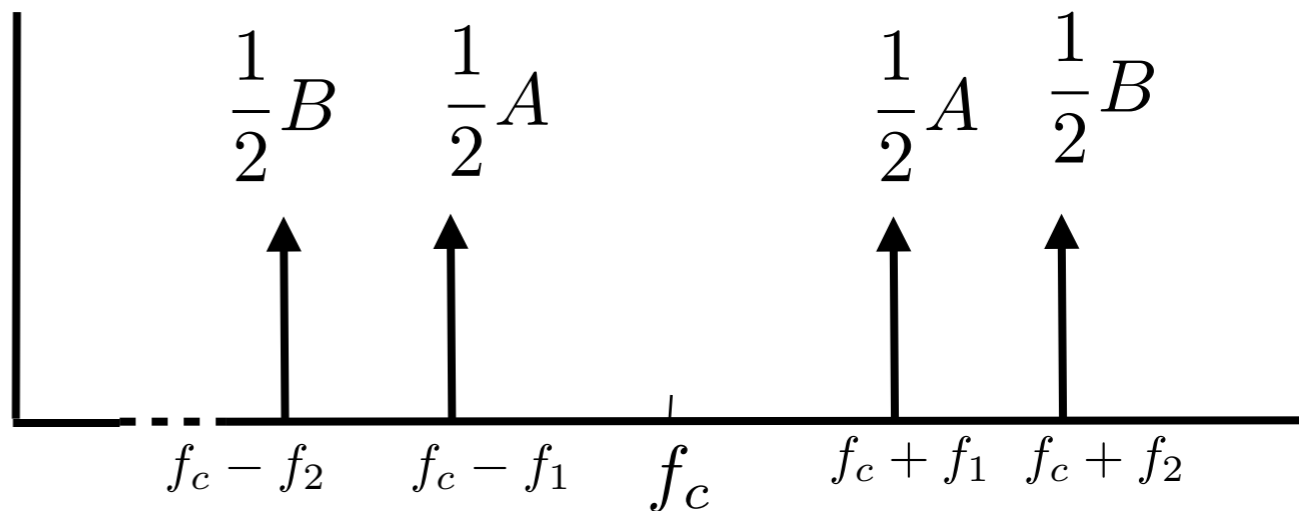

- Frequency response of the VSB filter

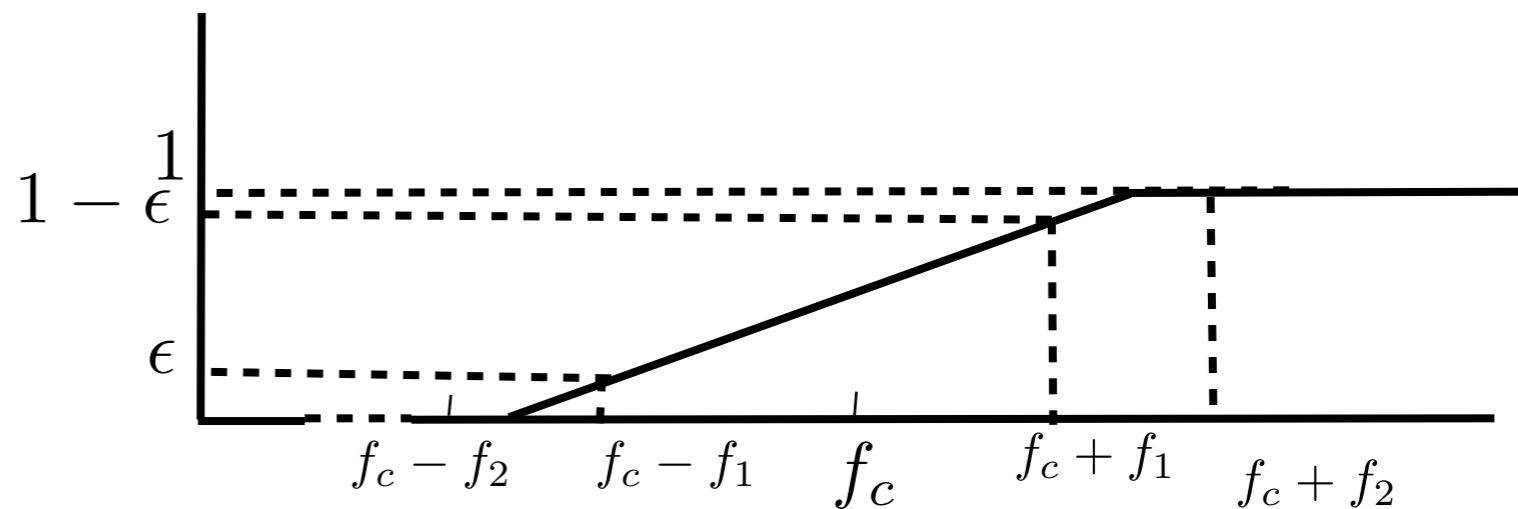

- Output response

$$s(t) = \frac{1}{2}A\epsilon \cos(2\pi(f_c - f_1)t) + \frac{1}{2}A(1 - \epsilon) \cos(2\pi(f_c + f_1)t) + \frac{1}{2}B \cos(2\pi(f_c + f_2)t)$$

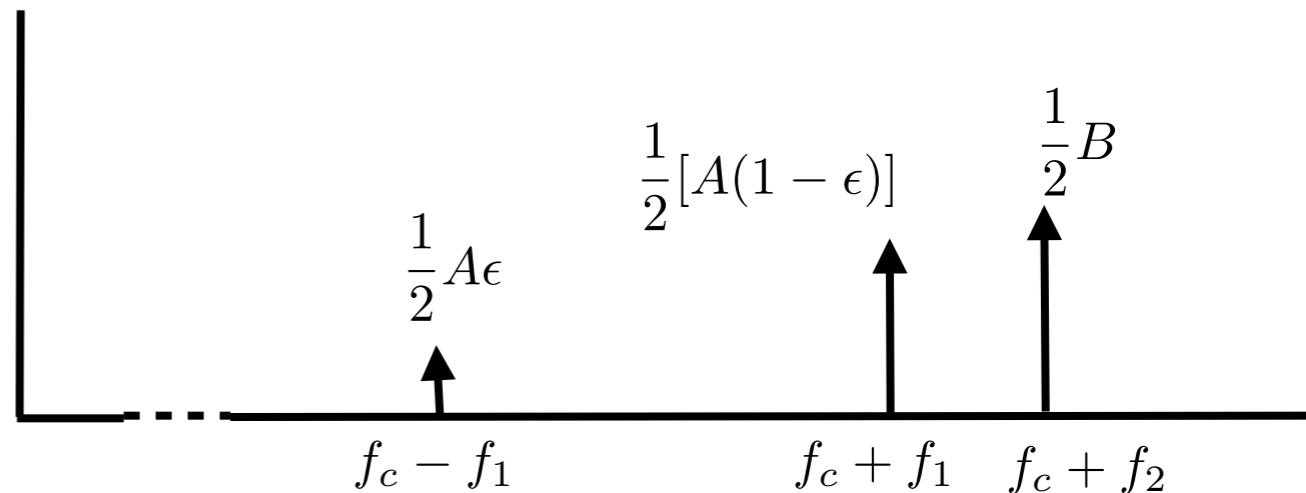

Demodulation of VSB Signal (Coherent method)

- Downconvert (by Multiplying $4 \cos(2\pi f_c t)$) and low pass filtering
- Downconvert

$$\begin{aligned}d(t) &= s(t) \cdot 4 \cos(2\pi f_c t) \\ &= \frac{1}{2} A \epsilon \cos(2\pi(f_c - f_1)t) \cdot 4 \cos(2\pi f_c t) \\ &\quad + \frac{1}{2} A(1 - \epsilon) \cos(2\pi(f_c + f_1)t) \cdot 4 \cos(2\pi f_c t) \\ &\quad + \frac{1}{2} B \cos(2\pi(f_c + f_2)t) \cdot 4 \cos(2\pi f_c t)\end{aligned}$$

$$\cos(2\pi(f_c + f_1)t) \cdot \cos(2\pi f_c t) = \frac{1}{2} \left[\cos(2\pi(2f_c + f_1)t) + \cos(2\pi f_1 t) \right]$$

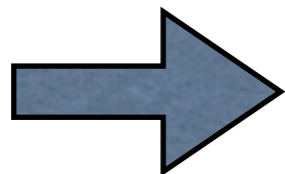

Low-Pass Filtering

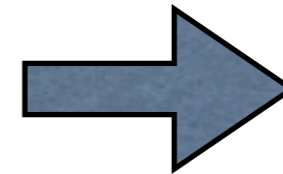

$$\frac{1}{2} \cos(2\pi f_1 t)$$

- Signal after Low-pass filtering

$$\begin{aligned}\nu(t) &= A\epsilon \cos(2\pi f_1 t) + A(1 - \epsilon) \cos(2\pi f_1 t) + B \cos(2\pi f_2 t) \\ &= A \cos(2\pi f_1 t) + B \cos(2\pi f_2 t)\end{aligned}$$

Television Signals

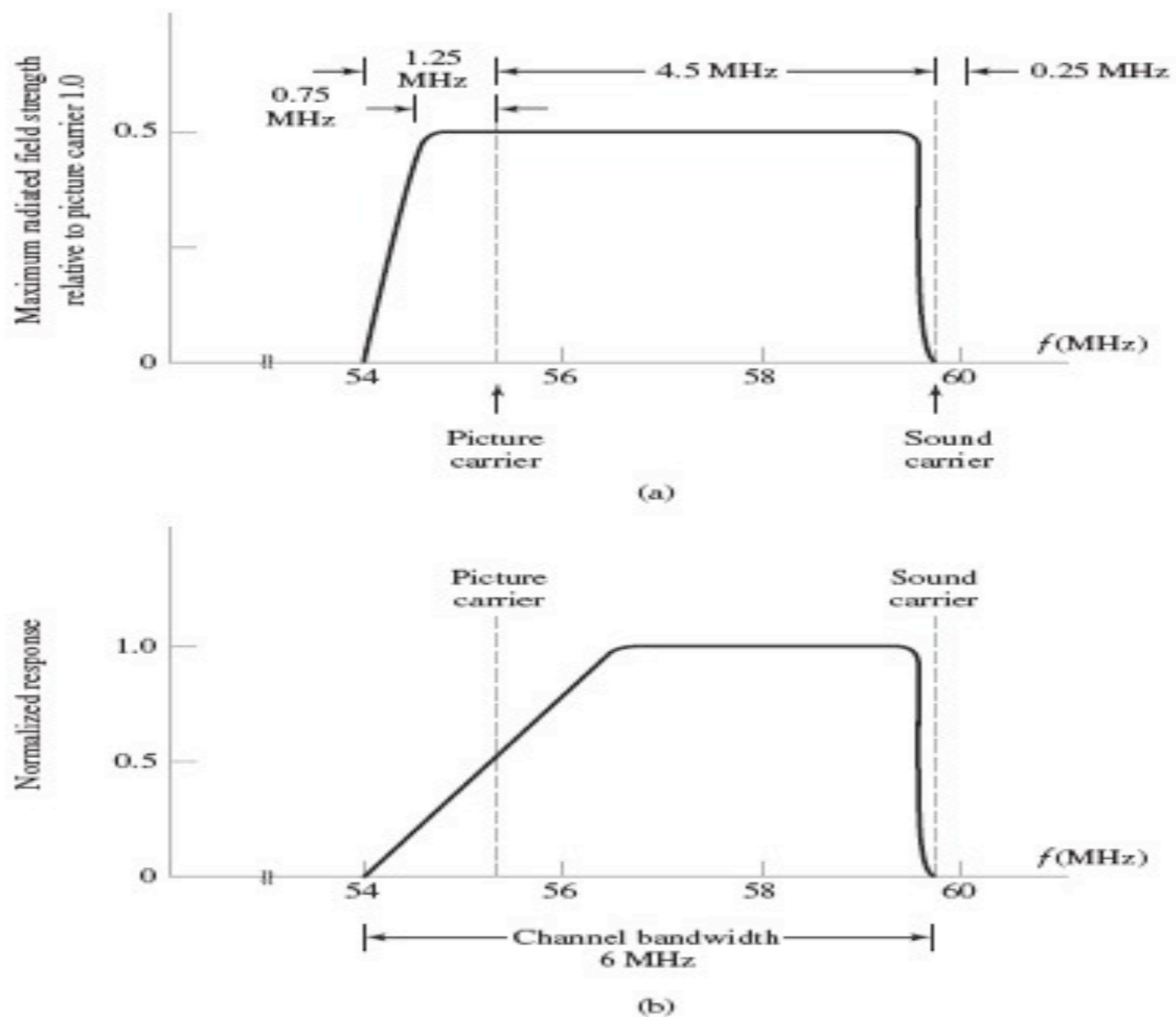

FIGURE 3.28 (a) Idealized amplitude spectrum of a transmitted TV signal. (b) Amplitude response of a VSB shaping filter in the receiver.

[Ref: Haykin & Moher, Textbook]

Baseband Representation of Modulated Waves

- DSB modulated wave signal

$$s_{DSB}(t) = Am(t) \cos(2\pi f_c t)$$

- SSB modulated wave signal

$$s_{SSB}(t) = \frac{1}{2}Am(t) \cos(2\pi f_c t) \pm \frac{1}{2}A\hat{m}(t) \sin(2\pi f_c t)$$

- In general, we can write the “linear modulated wave” as

$$s(t) = s_I(t) \cos(2\pi f_c t) - s_Q(t) \sin(2\pi f_c t)$$

Carrier wave with frequency f_c

$$c(t) = \cos(2\pi f_c t)$$

quadrature-phase version of the carrier

$$\hat{c}(t) = \sin(2\pi f_c t)$$

Orthogonal each other

- We can rewrite the modulated wave as

$$s(t) = s_I(t)c(t) - s_Q(t)\hat{c}(t)$$

in-phase component of $s(t)$

quadrature(-phase) component of $s(t)$

- Introduce the complex envelop of the modulated wave $s(t)$

$$\tilde{s}(t) = s_I(t) + js_Q(t)$$

- Define the complex carrier wave

$$\tilde{c}(t) = c_I(t) - jc_Q(t)$$

- Consider the following

$$\tilde{s}(t) \cdot \exp(j2\pi f_c t) = \left[s_I(t) + js_Q(t) \right] \cdot \left[\cos(2\pi f_c t) + j \sin(2\pi f_c t) \right]$$

- Real term

$$\Re \left[\tilde{s}(t) \cdot \exp(j2\pi f_c t) \right] = s_I(t) \cdot \cos(2\pi f_c t) - s_Q(t) \cdot \sin(2\pi f_c t)$$

- Imaginary term

$$\Im \left[\tilde{s}(t) \cdot \exp(j2\pi f_c t) \right] = s_I(t) \sin(2\pi f_c t) + s_Q(t) \cos(2\pi f_c t)$$

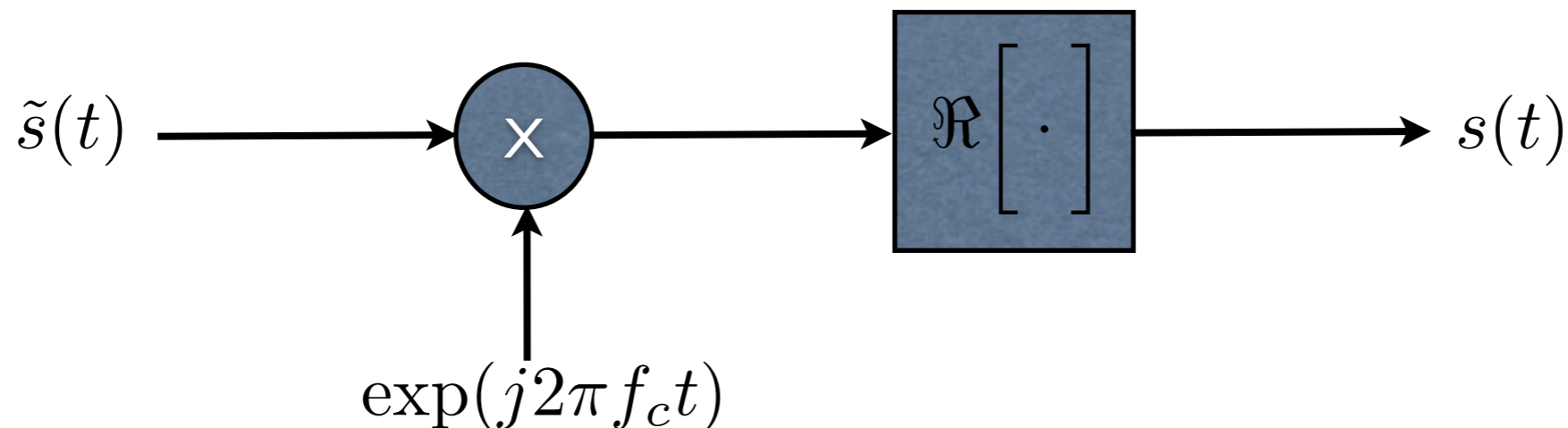

- Now consider

$$\tilde{s}(t) = s_I(t) + js_Q(t) = a(t)e^{j\theta(t)}$$

where

$$a(t) = \sqrt{s_I^2(t) + s_Q^2(t)}, \quad \theta(t) = \tan^{-1} \frac{s_Q(t)}{s_I(t)}$$

- Then we can represent the modulated wave as

$$\begin{aligned} s(t) &= \Re \left[\tilde{s}(t) e^{j2\pi f_c t} \right] = \Re \left[a(t) e^{j\theta(t)} e^{j2\pi f_c t} \right] \\ &= \Re \left[a(t) e^{j[2\pi f_c t + \theta(t)]} \right] \\ &= a(t) \cos[2\pi f_c t + \theta(t)] \end{aligned}$$

- Three different representation of modulated wave using its equivalent baseband signal

$$\begin{aligned} s(t) &= s_I(t) \cos(2\pi f_c t) - s_Q(t) \sin(2\pi f_c t) \\ &= \Re \left[\tilde{s}(t) e^{j2\pi f_c t} \right] \\ &= a(t) \cos[2\pi f_c t + \theta(t)] \end{aligned}$$

Superheterodyne Receiver

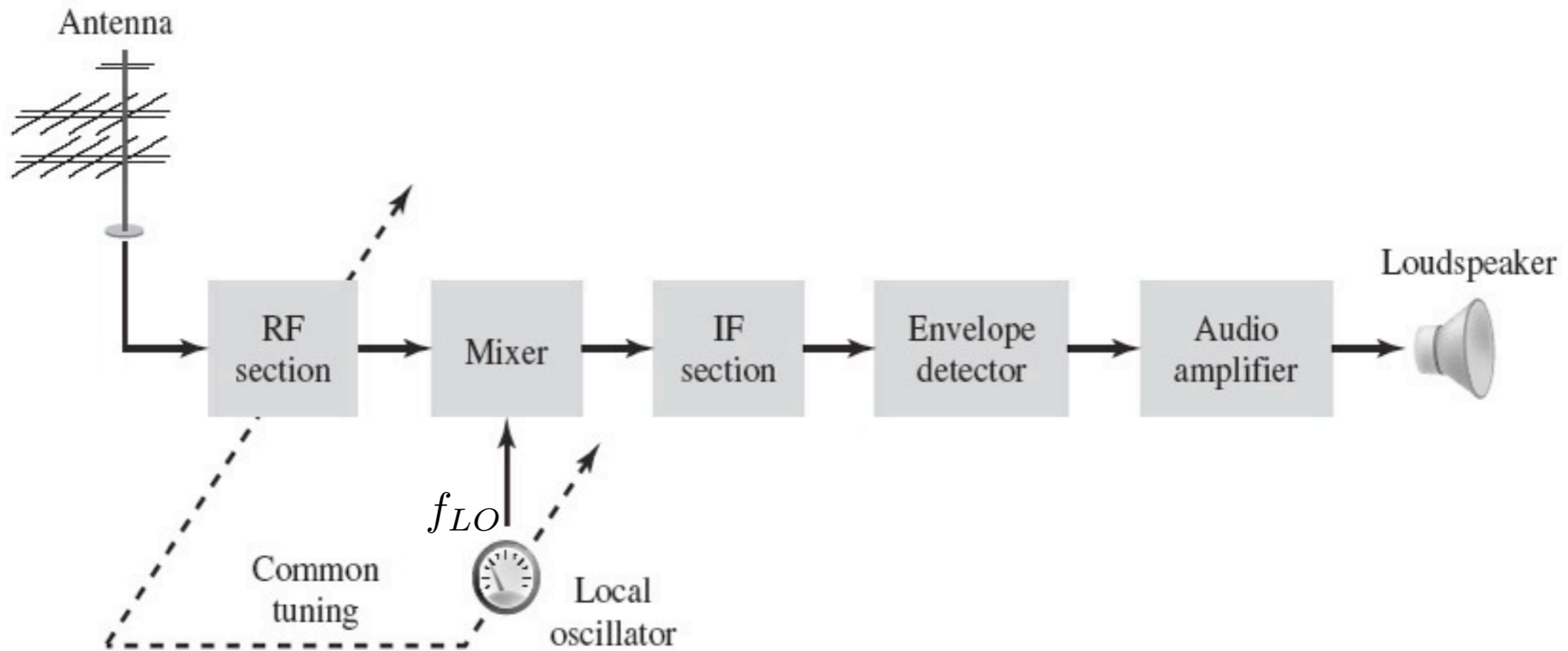
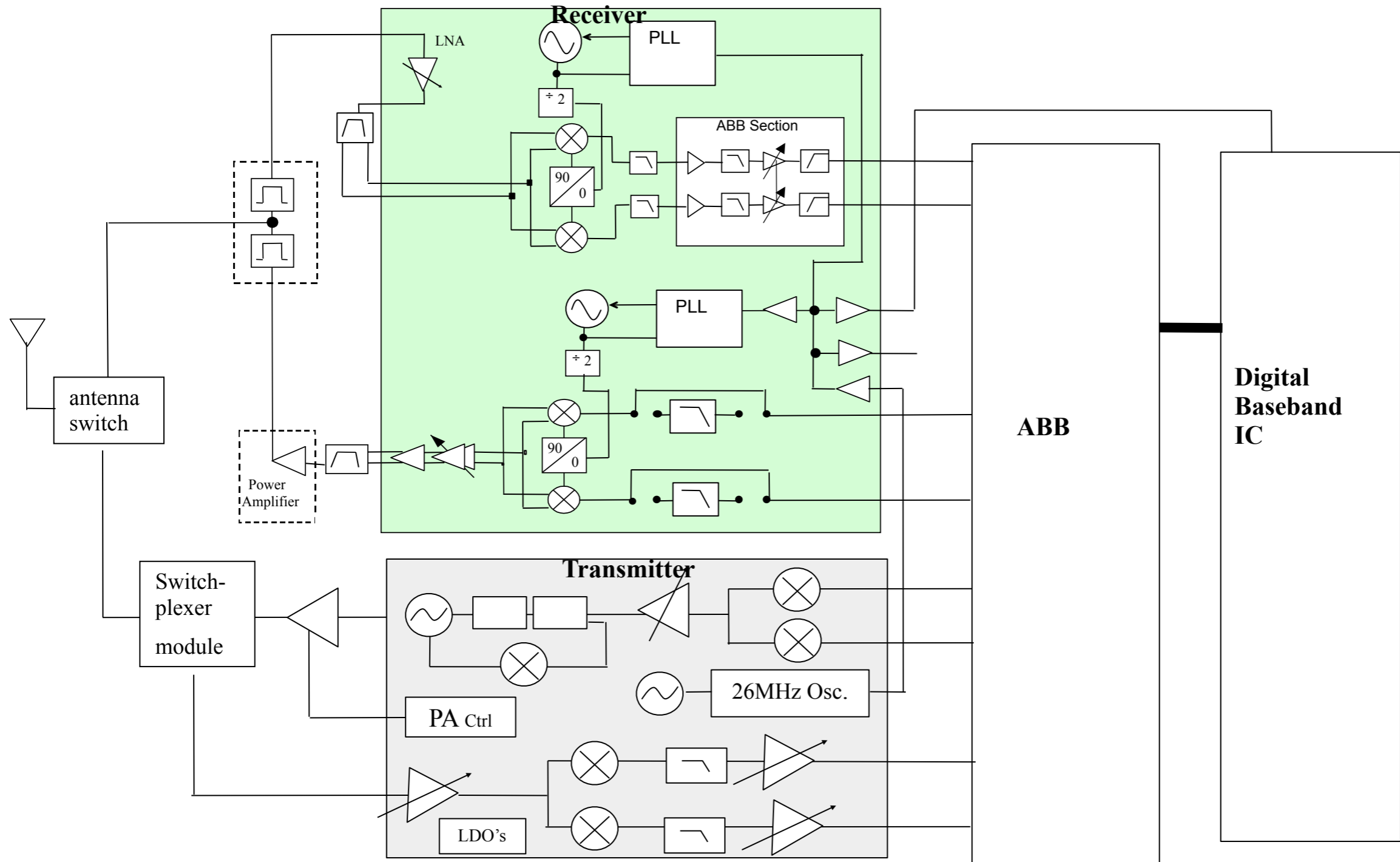

FIGURE 3.27 Basic elements of an AM radio receiver of the superheterodyne type.

TABLE 3.2 Typical Frequency Parameters of AM and FM Radio Receivers

	AM Radio	FM Radio
RF carrier range	0.535–1.605 MHz	88–108 MHz
Mid-band frequency of IF section	0.455 MHz	10.7 MHz
IF bandwidth	10 kHz	200 kHz

Communication Chipset Architecture



Frequency-Division Multiplexing

- To transmit a number of communication signals over the same channel, the signals must be kept apart so that they do not interfere with each other, and thus they can be separated at the receiving end.
- FDM (Frequency division multiplexing)
- TDM (Time division multiplexing)
- SDM (Space division multiplexing)
- CDM (Code division multiplexing)

Block Diagram of FDM

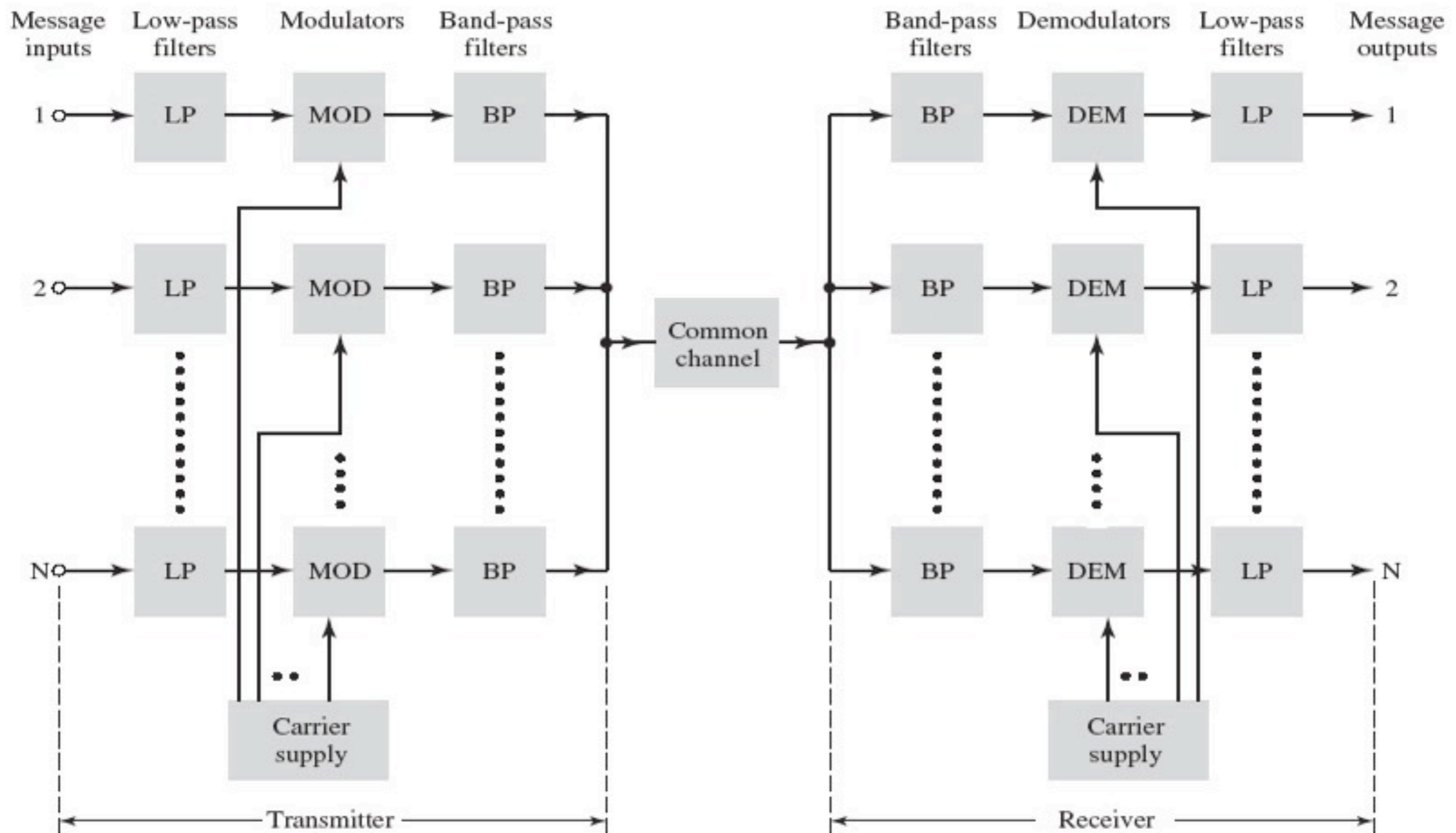

FIGURE 3.29 Block diagram of frequency-division multiplexing (FDM) system.

[Ref: Haykin Textbook]