

KECE321 Communication Systems I

(Haykin Sec. 3.1)

Lecture #8, April 2, 2012
Prof. Young-Chai Ko

Bandwidth

- Definition of bandwidth
- Bandwidth of a signal is the frequency region of which the significant spectral content reside for positive frequencies.
- Example

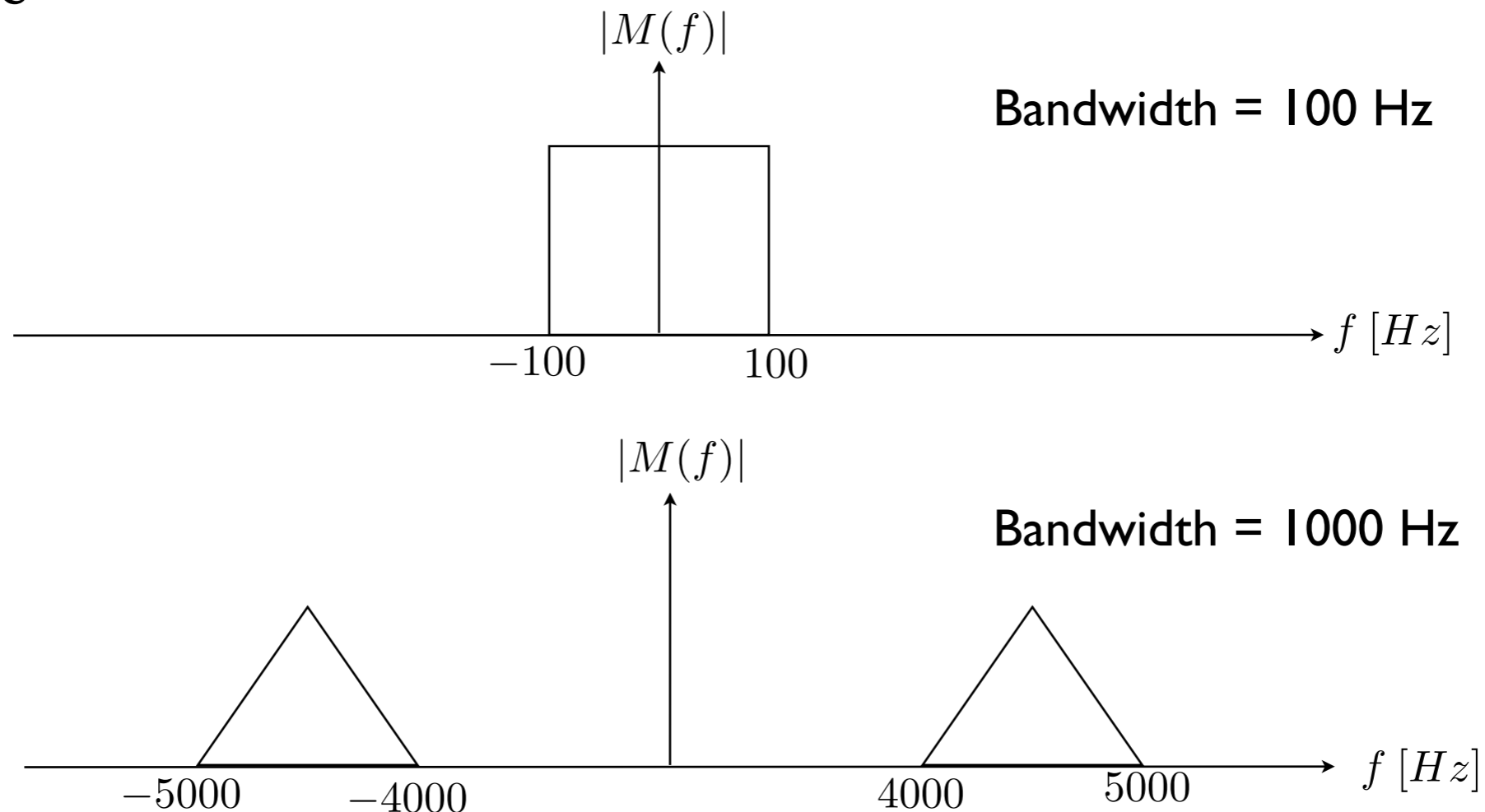

■ Category of bandwidth

- Null-to-null bandwidth

- 3-dB bandwidth (Half-power bandwidth)

$$\int_{f_1}^{f_1+W_{3dB}} |M(f)|^2 df = \frac{1}{2} \int_0^{\infty} |M(f)|^2 df$$

- root mean-square (rms) bandwidth

$$W_{rms} = \left(\frac{\int_{-\infty}^{\infty} f^2 |M(f)|^2 df}{\int_{-\infty}^{\infty} |M(f)|^2 df} \right)^{1/2}$$

Introduction to Amplitude Modulation

- Consideration of communication system design
 - Complexity
 - Two primary communication resources
 - Transmit power
 - Channel bandwidth
- Carrier
 - Carrier is a signal to move the baseband signal to the passband signal
 - A commonly used carrier is a sinusoidal wave

- Amplitude modulation family
 - Amplitude modulation
 - Double sideband-suppressed carrier (DSB-SC)
 - Single sideband (SSB)
 - Vestigial sideband (VSB)

Amplitude Modulation

- Theory

- Consider a sinusoidal carrier wave

$$c(t) = A_c \cos(2\pi f_c t)$$

- Denote the message signal (information bearing signal) as $m(t)$

- Transmission: Then an amplitude-modulated (AM) wave is

$$s(t) = A_c [1 + k_a m(t)] \cos(2\pi f_c t)$$

- Receiver: Envelope detector

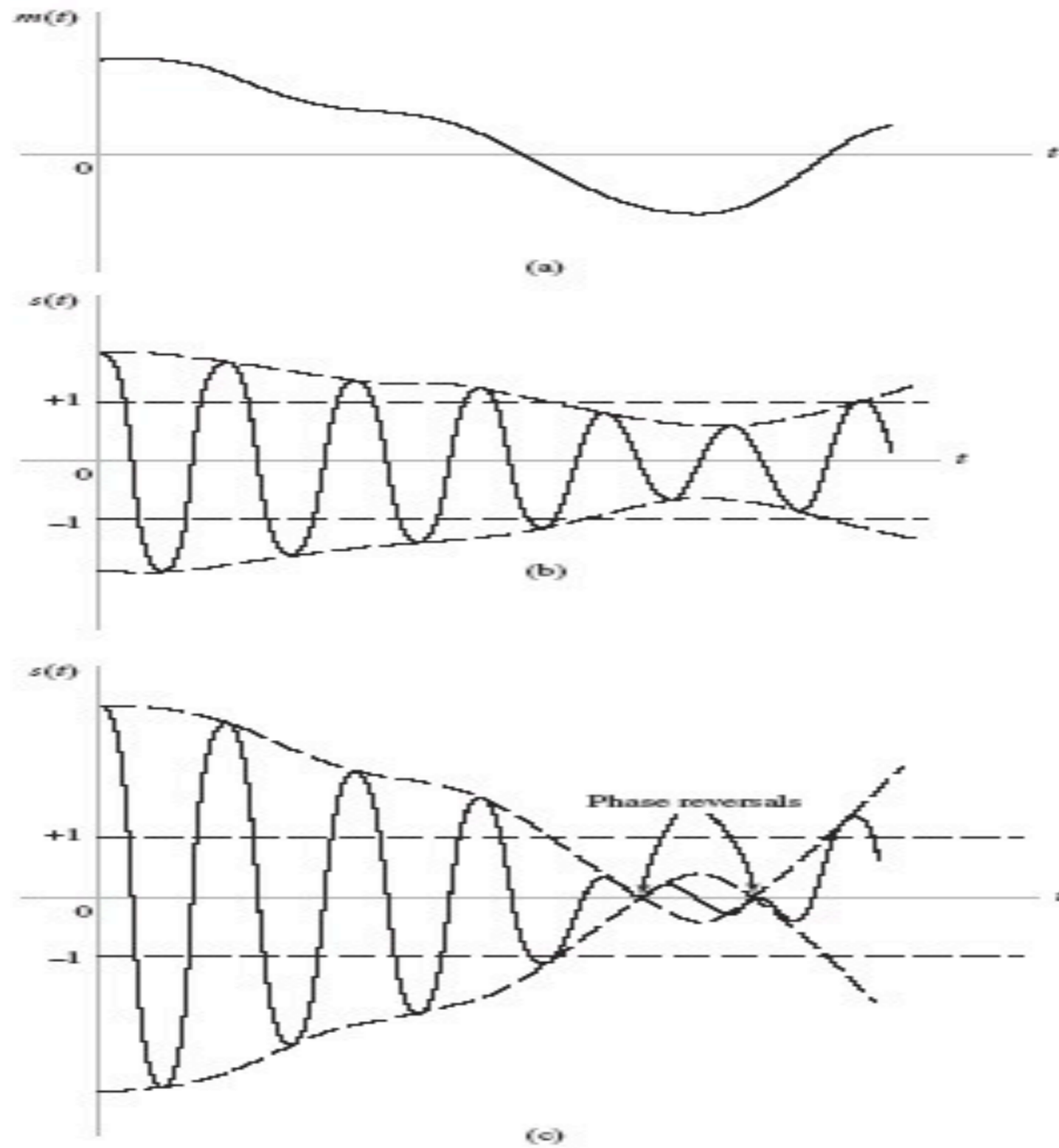

FIGURE 3.1 Illustration of the amplitude modulation process. (a) Message signal $m(t)$. (b) AM wave for $k_a m(t) < 1$ for all t . (c) AM wave for $|k_a m(t)| > 1$ for some t .

[Ref: Haykin & Moher, Textbook]

Carrier Wave

- Recall that the cosine function (or sine function) can shift the band by the frequency of the cosine function.

$$\mathcal{F}[m(t)] = M(f)$$

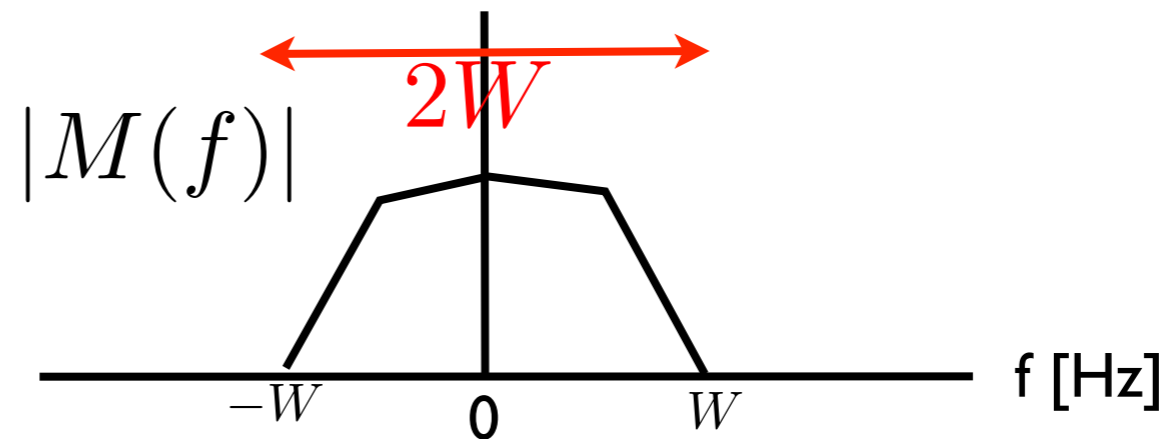

$$\mathcal{F}[m(t) \cos(2\pi f_c t)] = \frac{1}{2} [M(f - f_c) + M(f + f_c)]$$

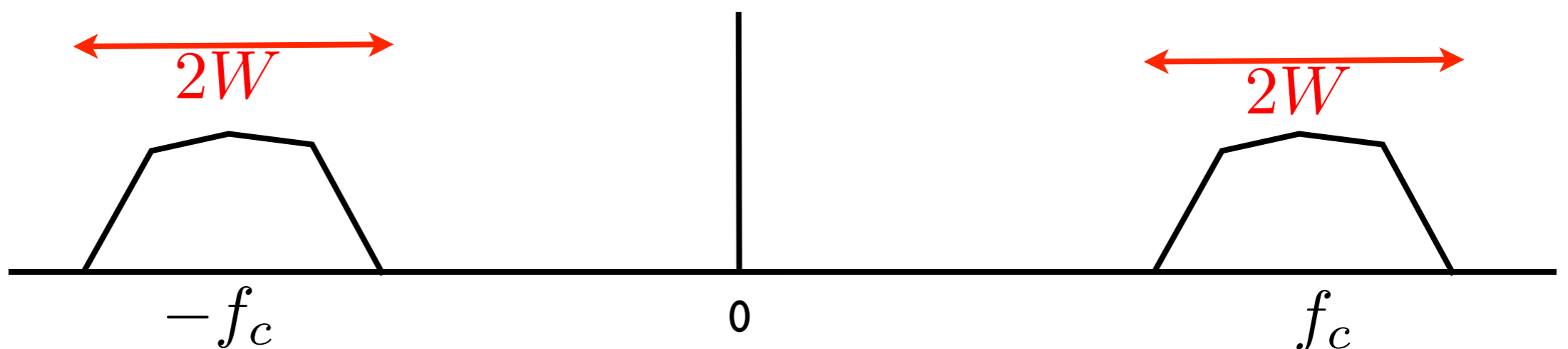

- Carrier wave (or signal)
 - Carrier wave is a signal to move (translate) the baseband signal to the passband signal.
 - A commonly used carrier is a sinusoidal wave.

Amplitude Modulation

- Theory

- Consider a sinusoidal carrier wave

$$c(t) = A_c \cos(2\pi f_c t)$$

- Denote the message signal (information bearing signal) as $m(t)$

- Transmission: Then an amplitude-modulated (AM) wave is

$$s(t) = A_c [1 + k_a m(t)] \cos(2\pi f_c t)$$

- Receiver: Envelope detector

Waveform of the multiplication of the signal and the sinusoidal function

- Consider $m(t) = e^{-t}$ of which the waveform is illustrated as below:

- Now consider the carrier wave given as $c(t) = \cos(10\pi t)$

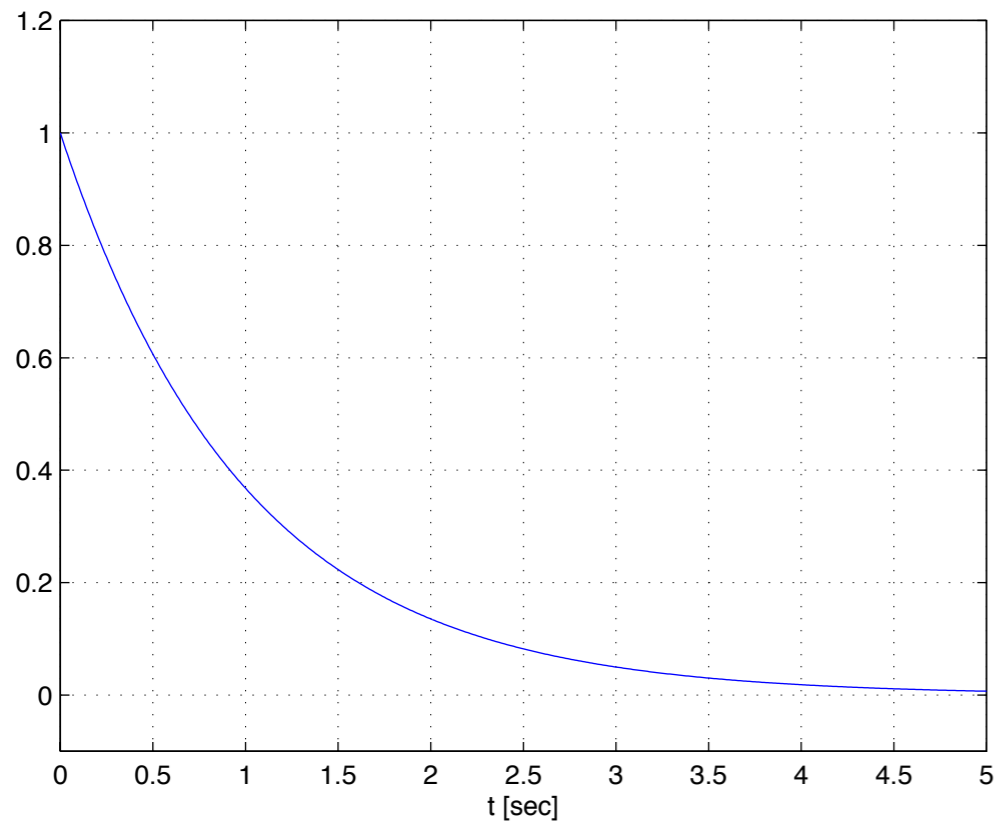

Waveform of the multiplication of the signal and the sinusoidal function

- Consider $m(t) = e^{-t}$ of which the waveform is illustrated as below:

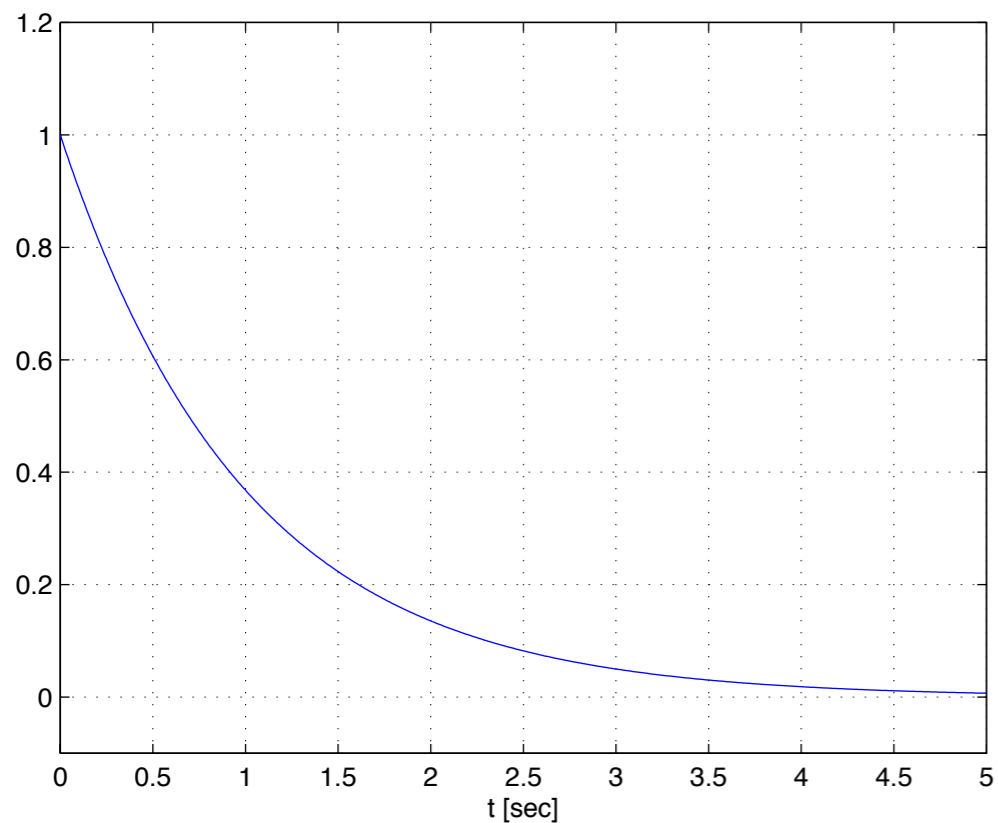

- Now consider the carrier wave given as $c(t) = \cos(10\pi t)$

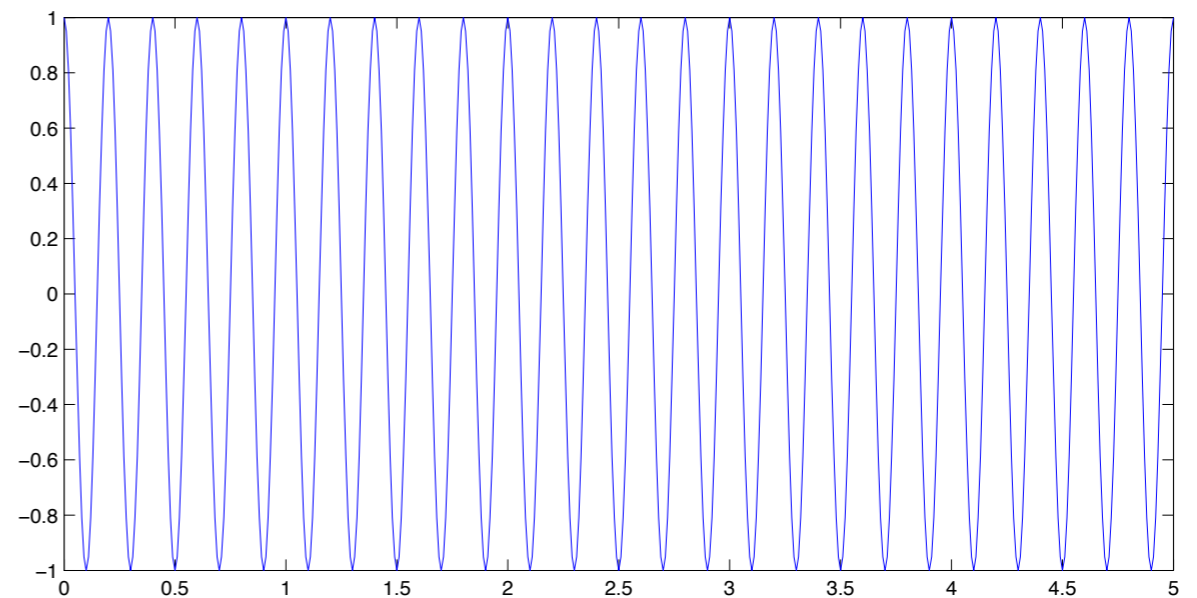

- Waveform of $m(t) \times c(t)$

- Waveform of $m(t) \times c(t)$

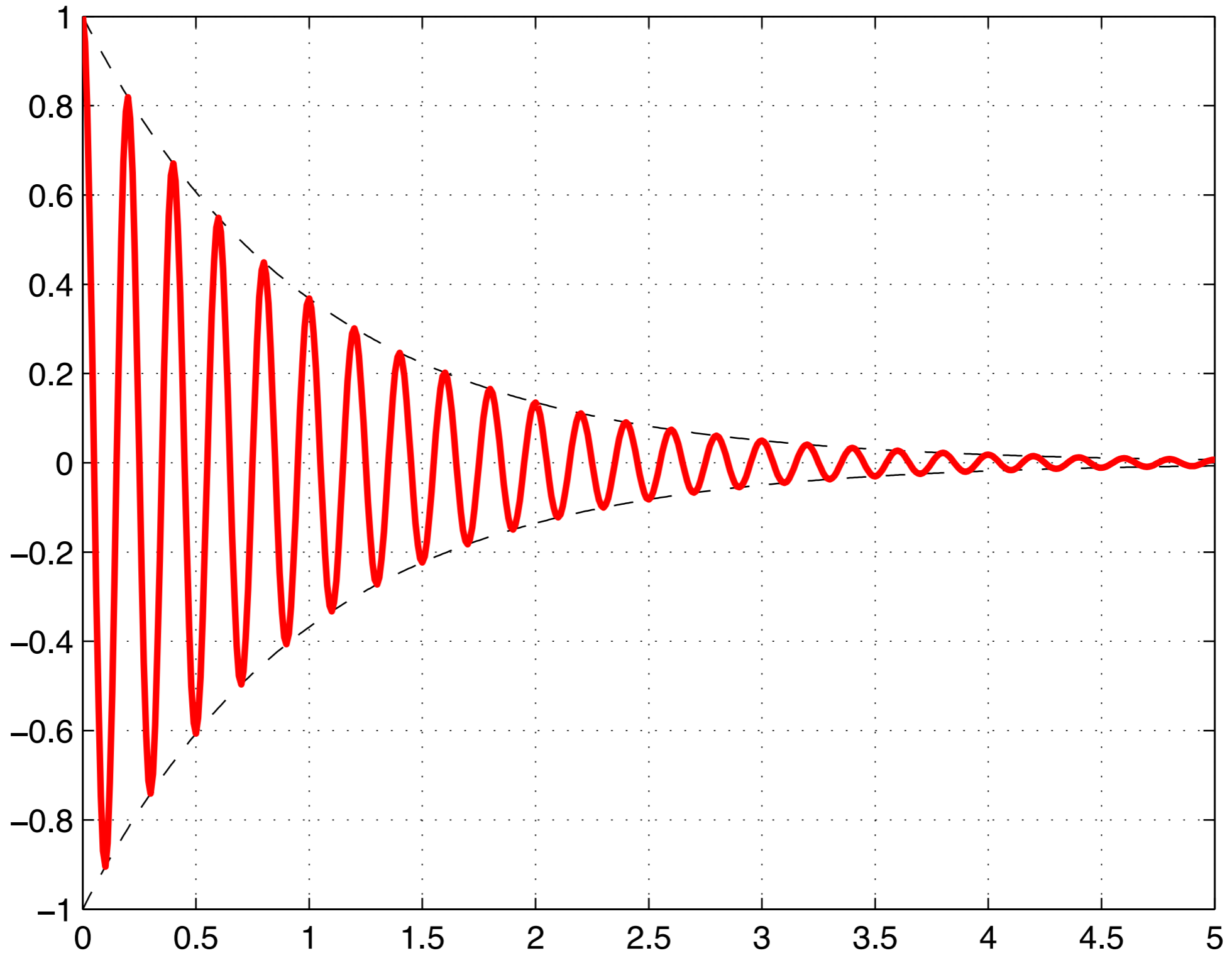

- Now consider $m(t) = t^2 - 6t + 8$

- Waveform of $m(t) \times c(t)$

-

- Now consider $m(t) = t^2 - 6t + 8$

- Waveform of $m(t) \times c(t)$

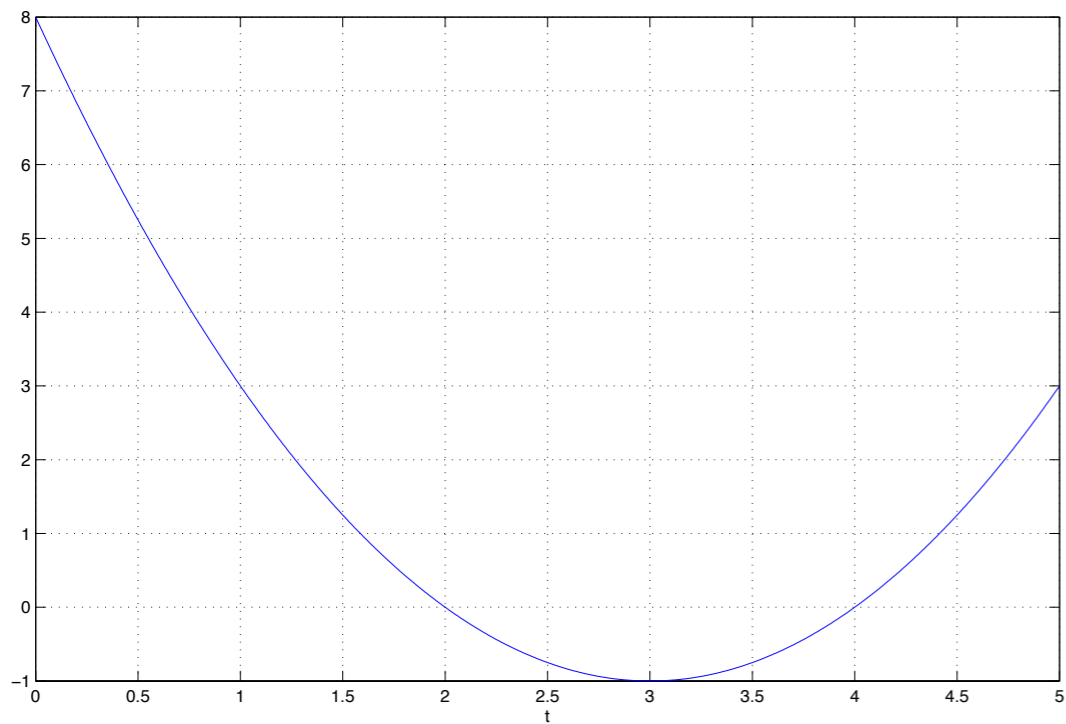

- Now consider $m(t) = t^2 - 6t + 8$

- Waveform of $m(t) \times c(t)$

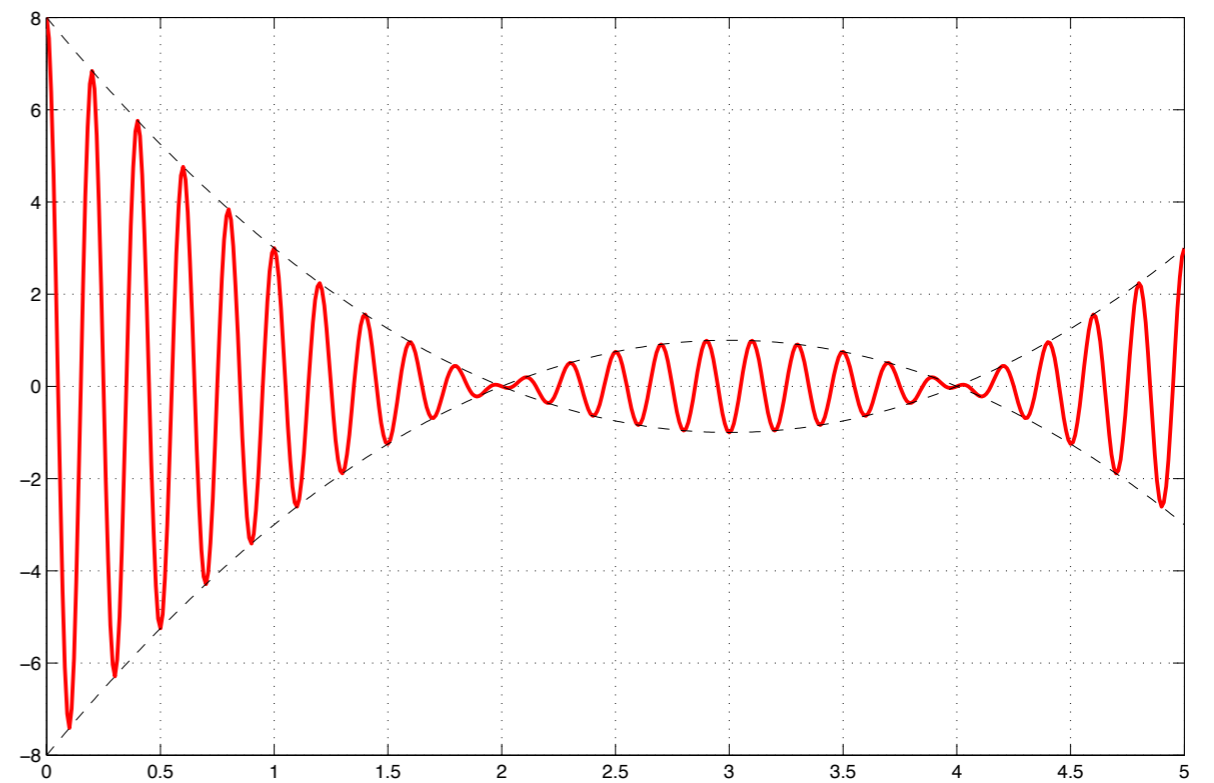
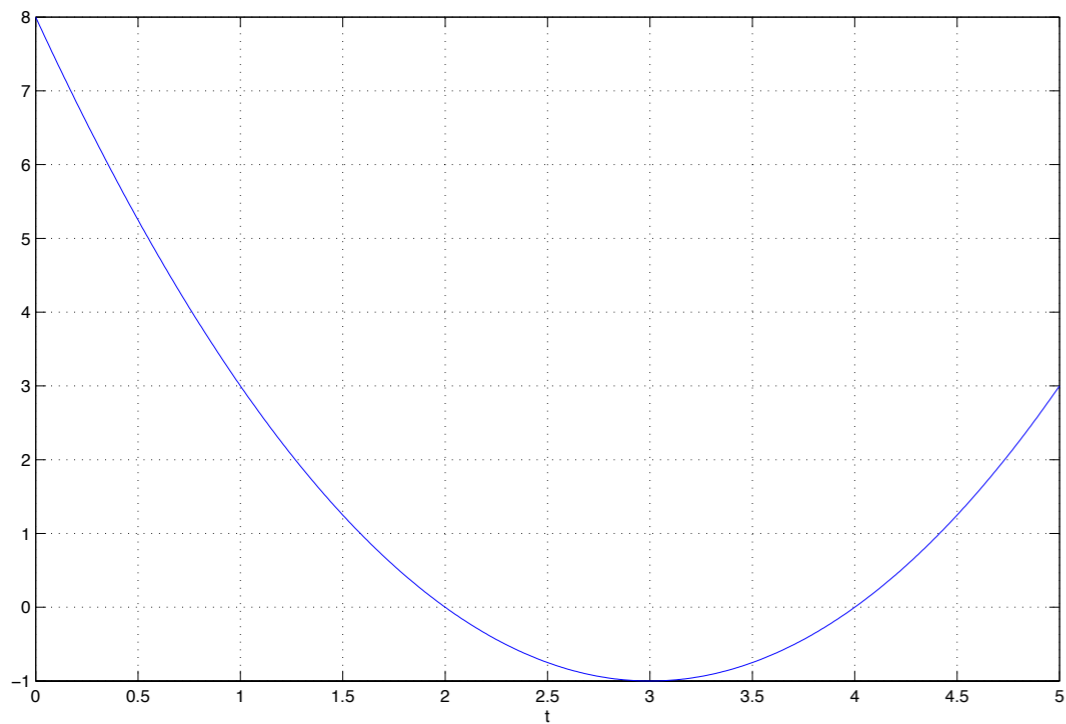

- Now consider $m(t) = t^2 - 6t + 8$

- Waveform of $m(t) \times c(t)$

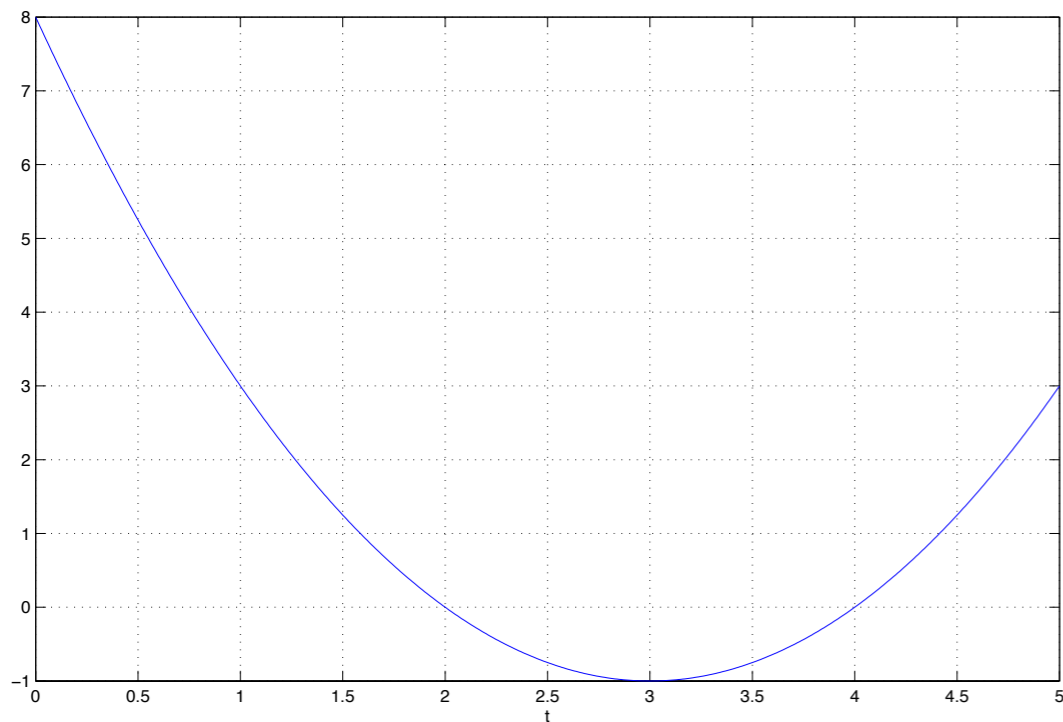

Envelope distortion!

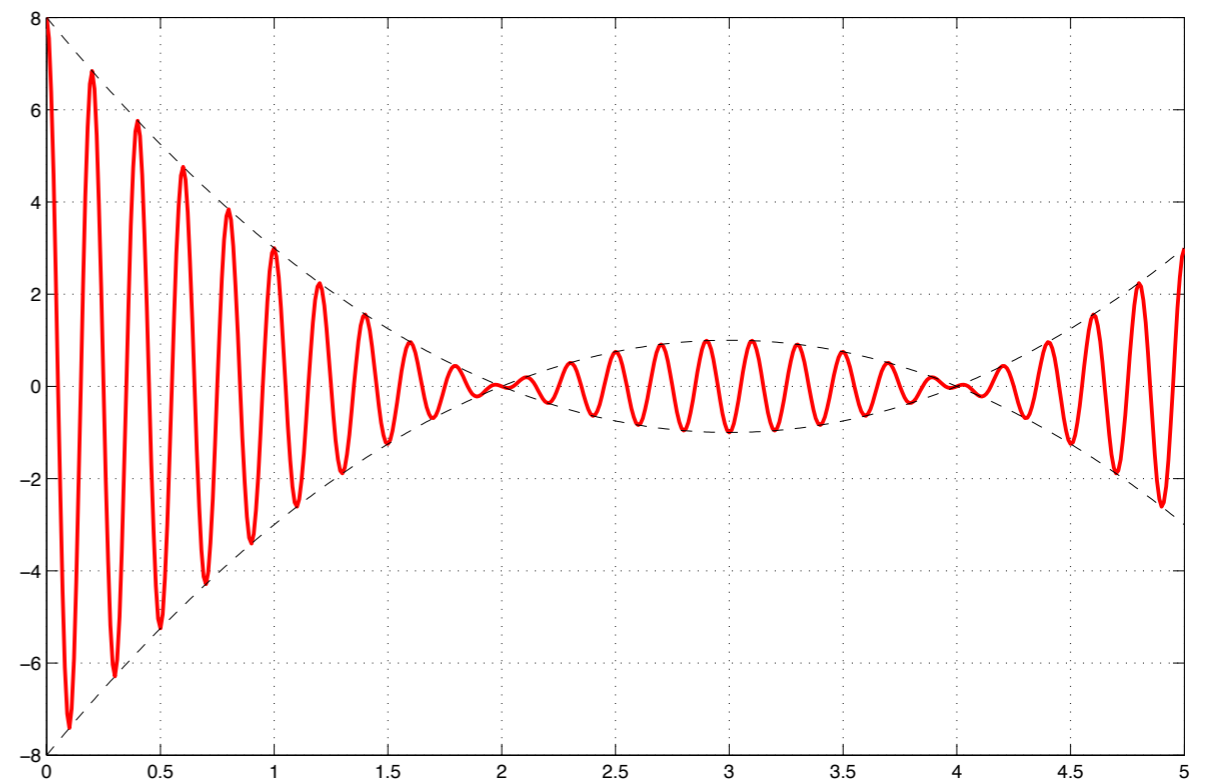

- Now consider $m(t) = t^2 - 6t + 9$

- Now consider $m(t) = t^2 - 6t + 9$

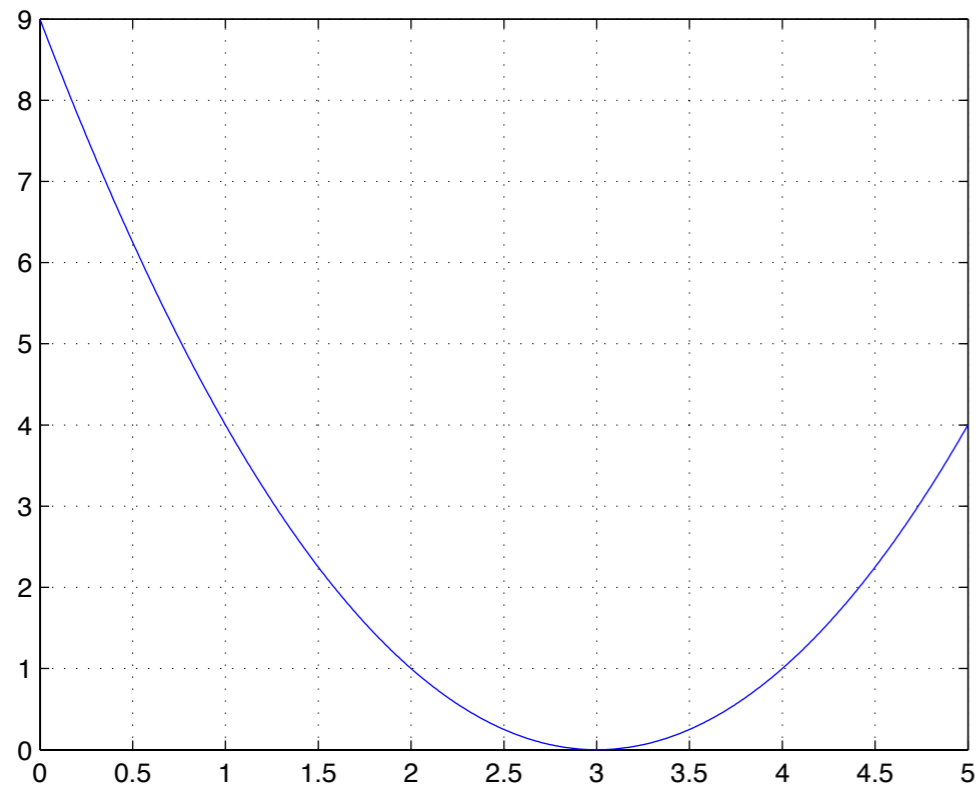

- Now consider $m(t) = t^2 - 6t + 9$

- Waveform of

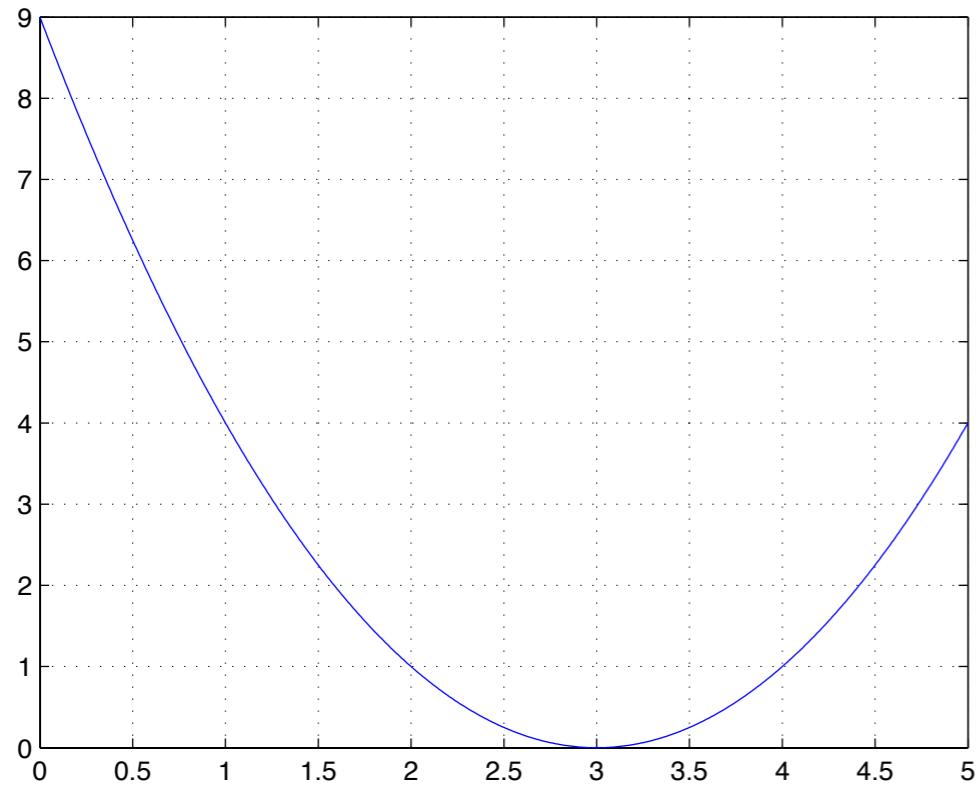

- Now consider $m(t) = t^2 - 6t + 9$

- Waveform of $m(t) \times c(t)$

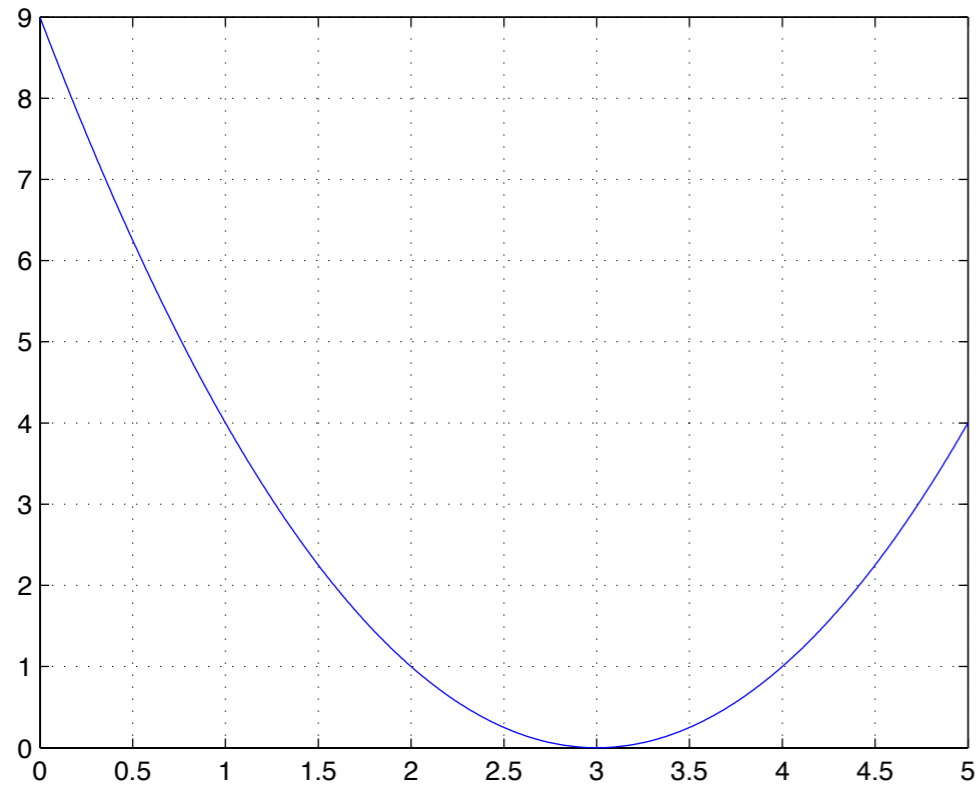

- Now consider $m(t) = t^2 - 6t + 9$

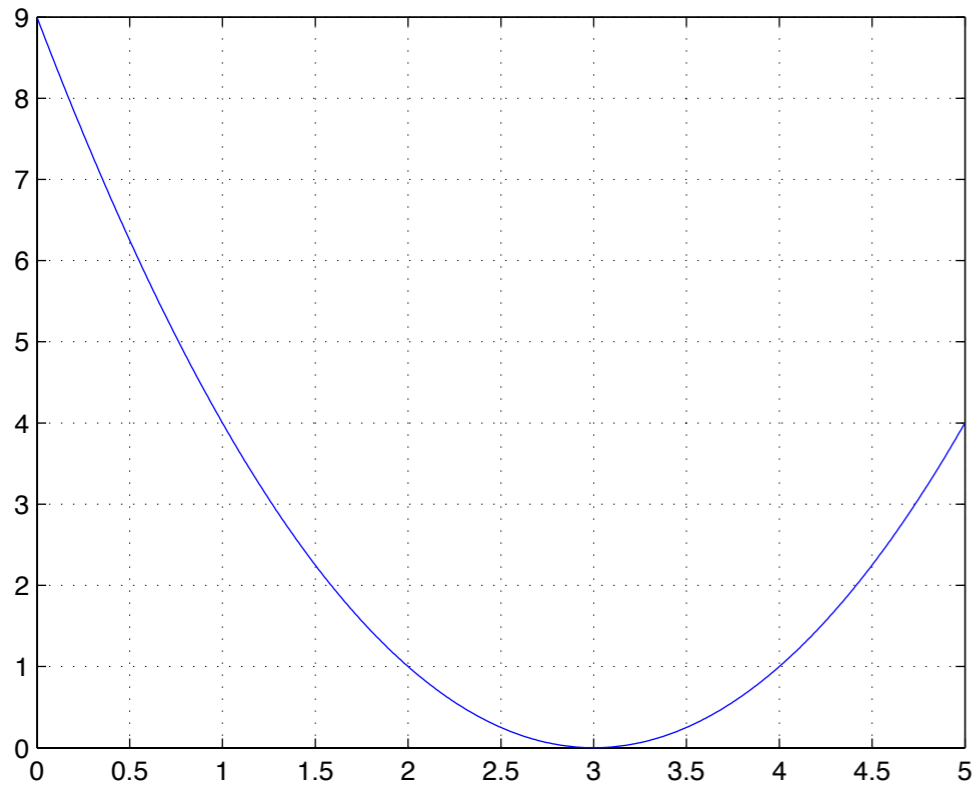

- Waveform of $m(t) \times c(t)$

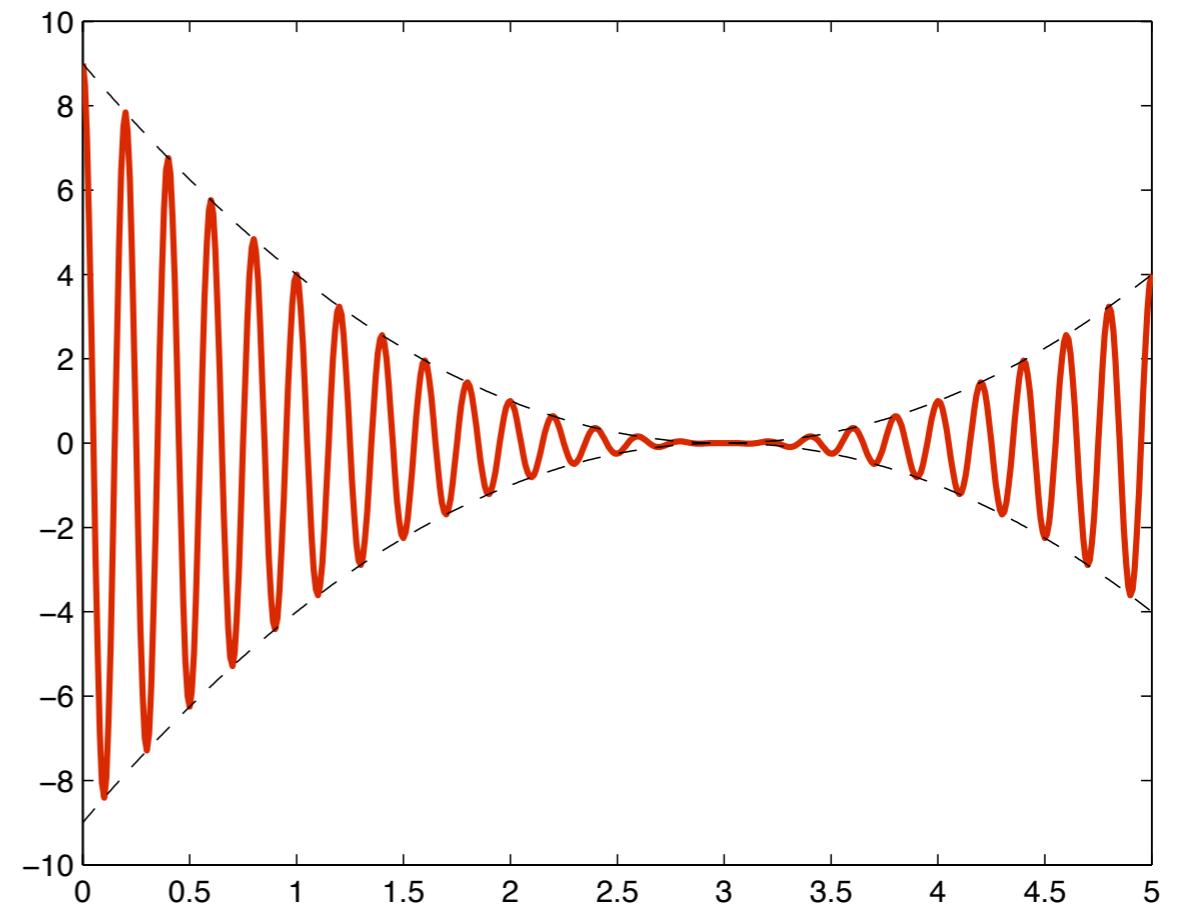

- Now consider $m(t) = t^2 - 6t + 5$

- Waveform of $m(t) \times c(t)$

- Now consider $m(t) = t^2 - 6t + 5$

- Waveform of $m(t) \times c(t)$

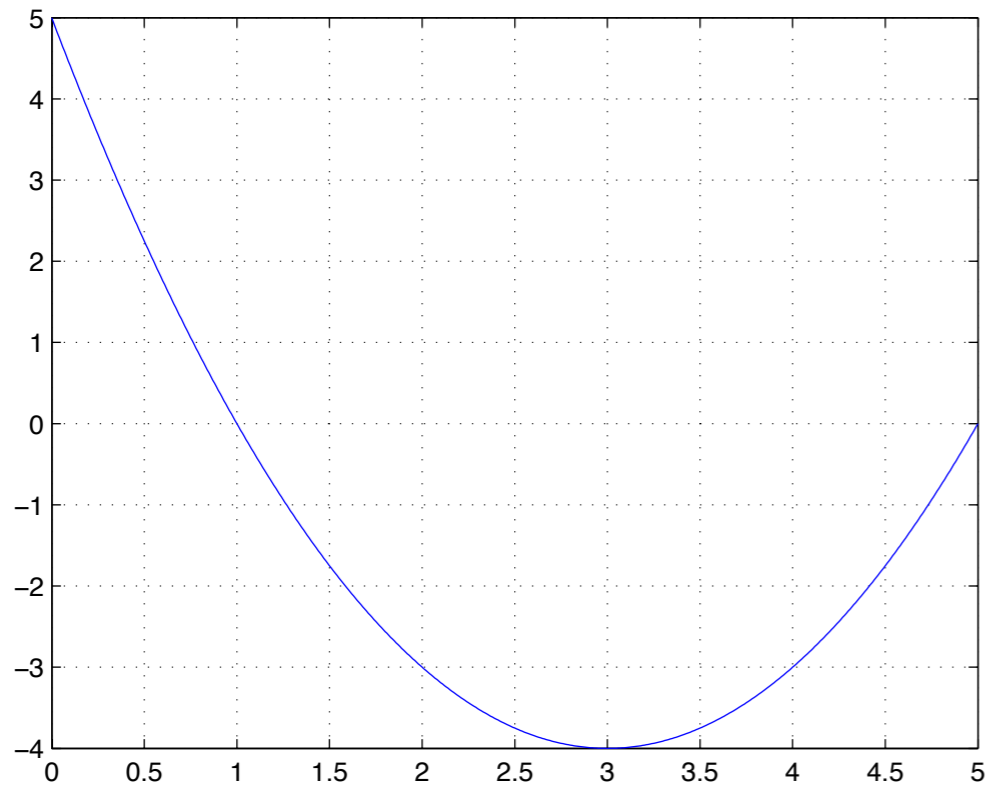

- Now consider $m(t) = t^2 - 6t + 5$

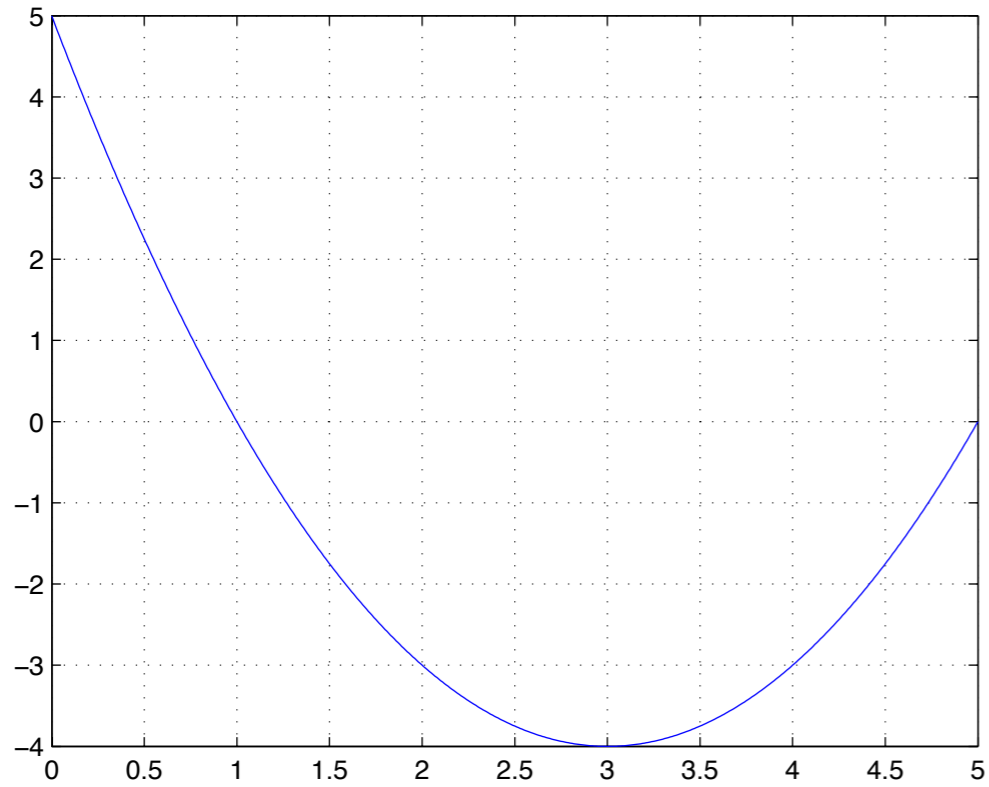

- Waveform of $m(t) \times c(t)$

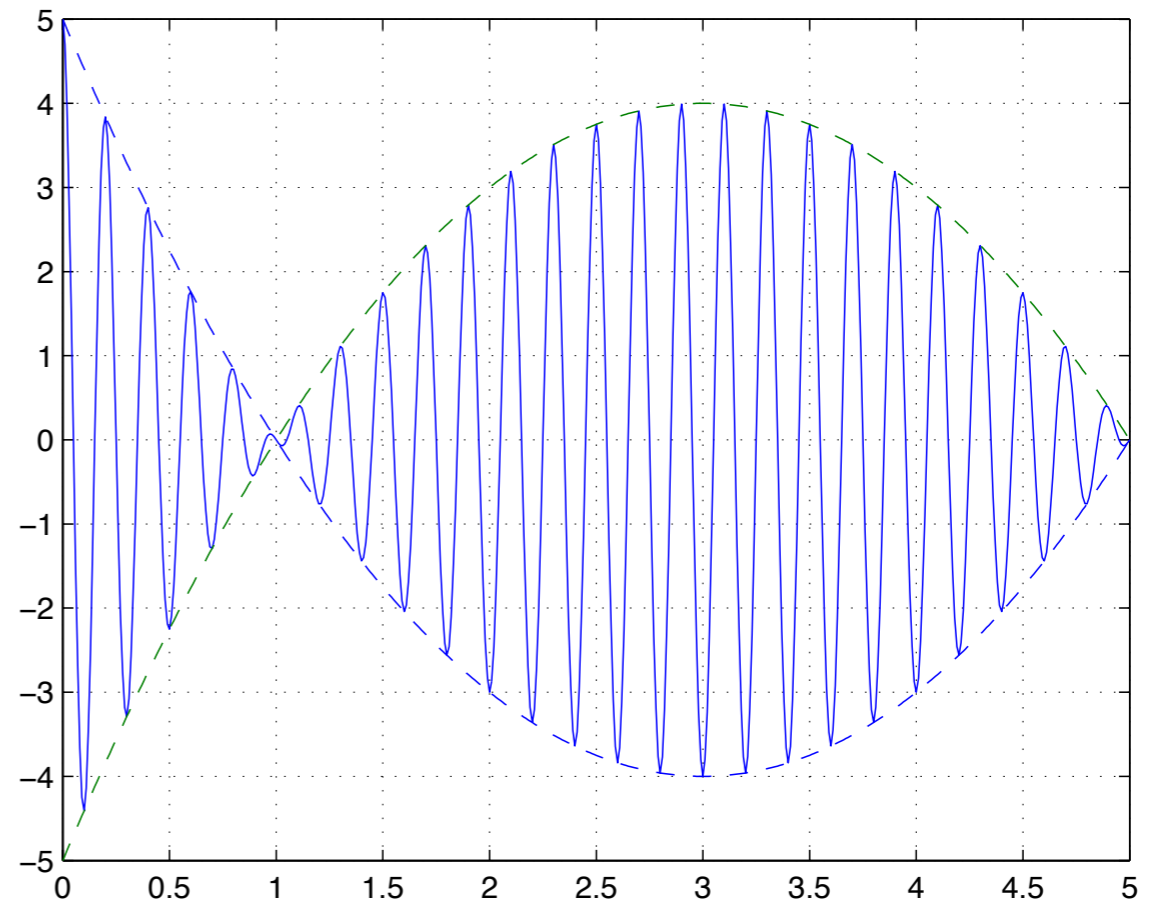

- Now let us do “amplitude modulation” such as

$$s(t) = [1 + k_a m(t)]c(t)$$

where we set k_a to be $|k_a m(t)| < 1$ such as

$$k_a = \frac{1}{\max|m(t)|}$$

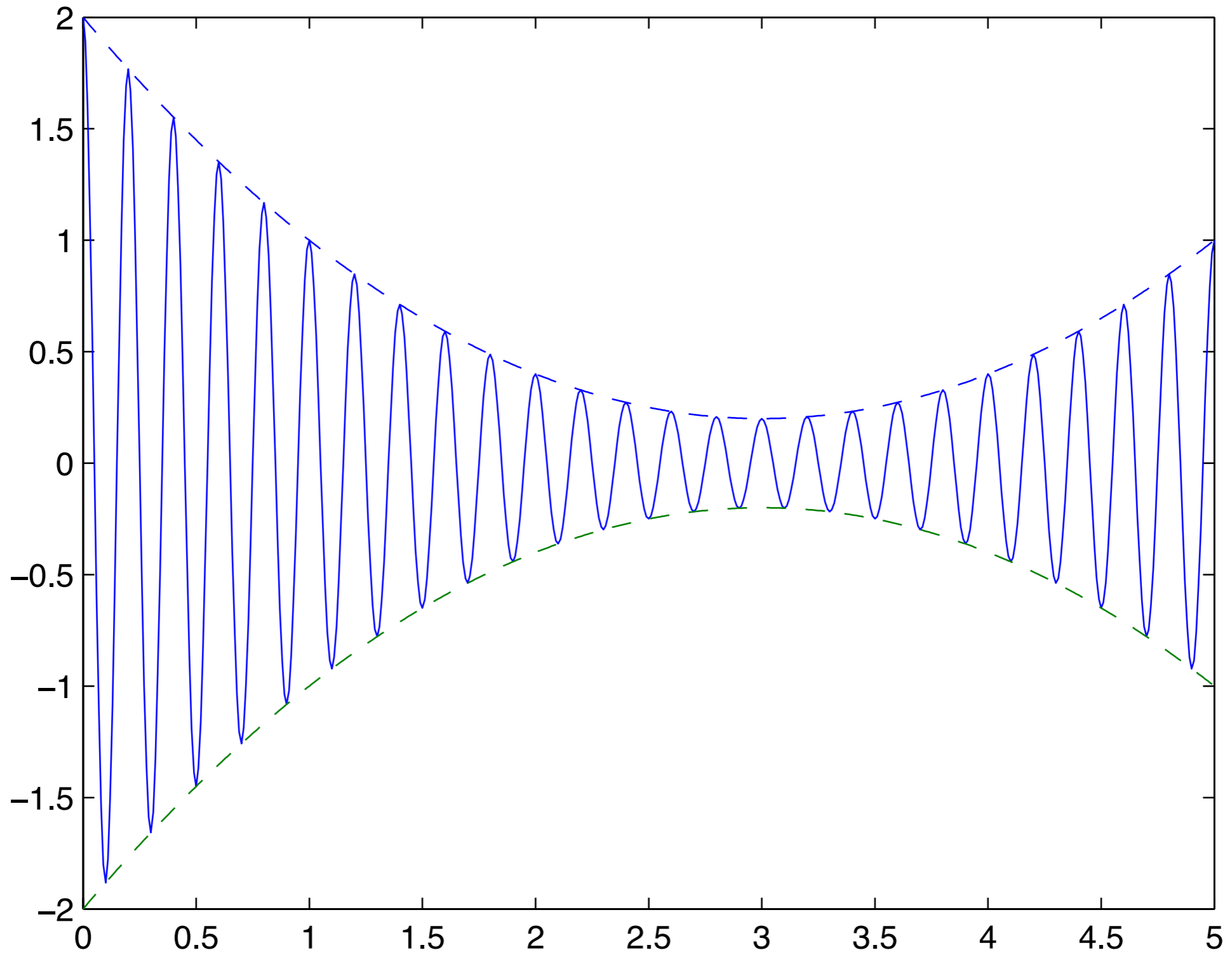

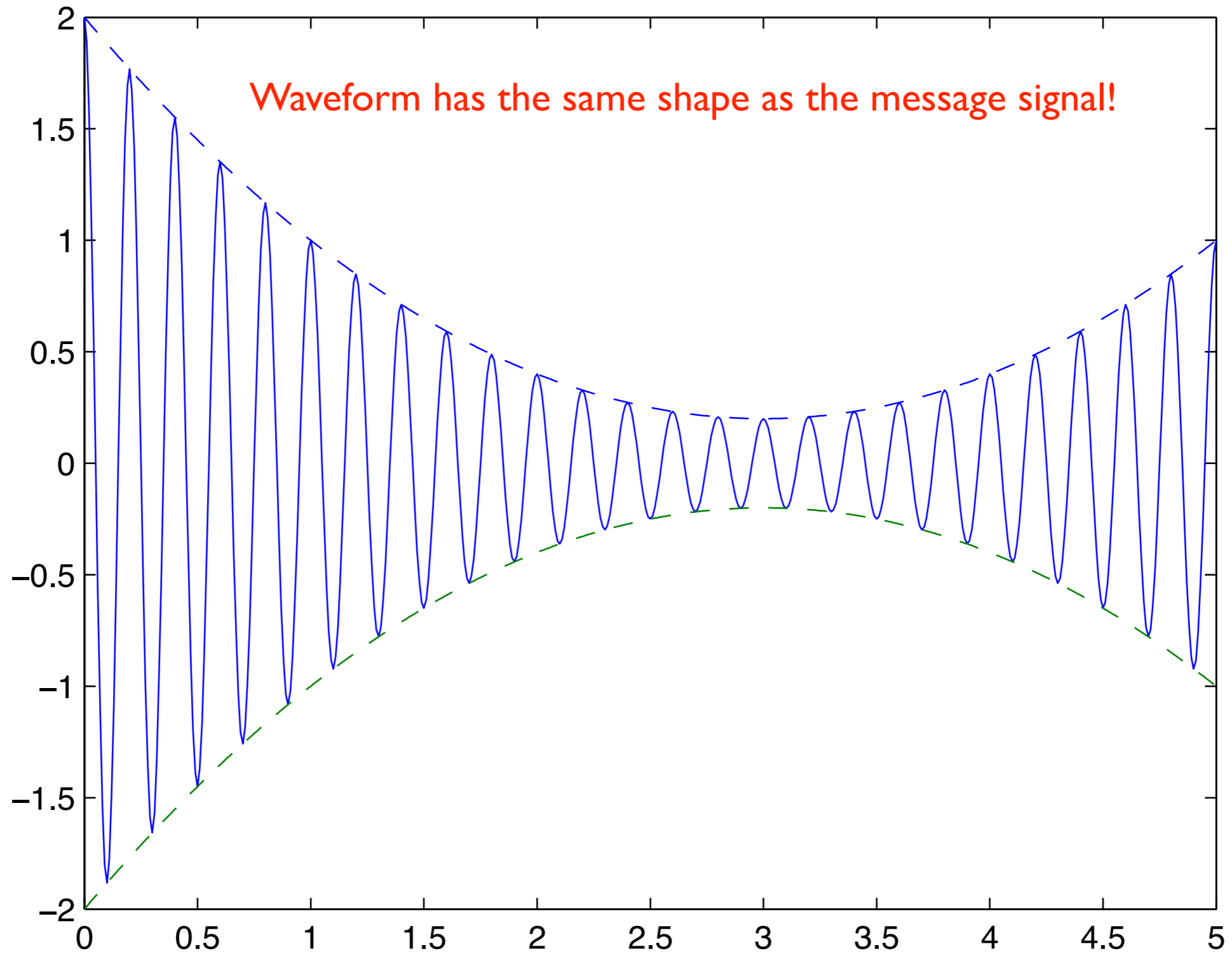

Waveform has the same shape as the message signal!

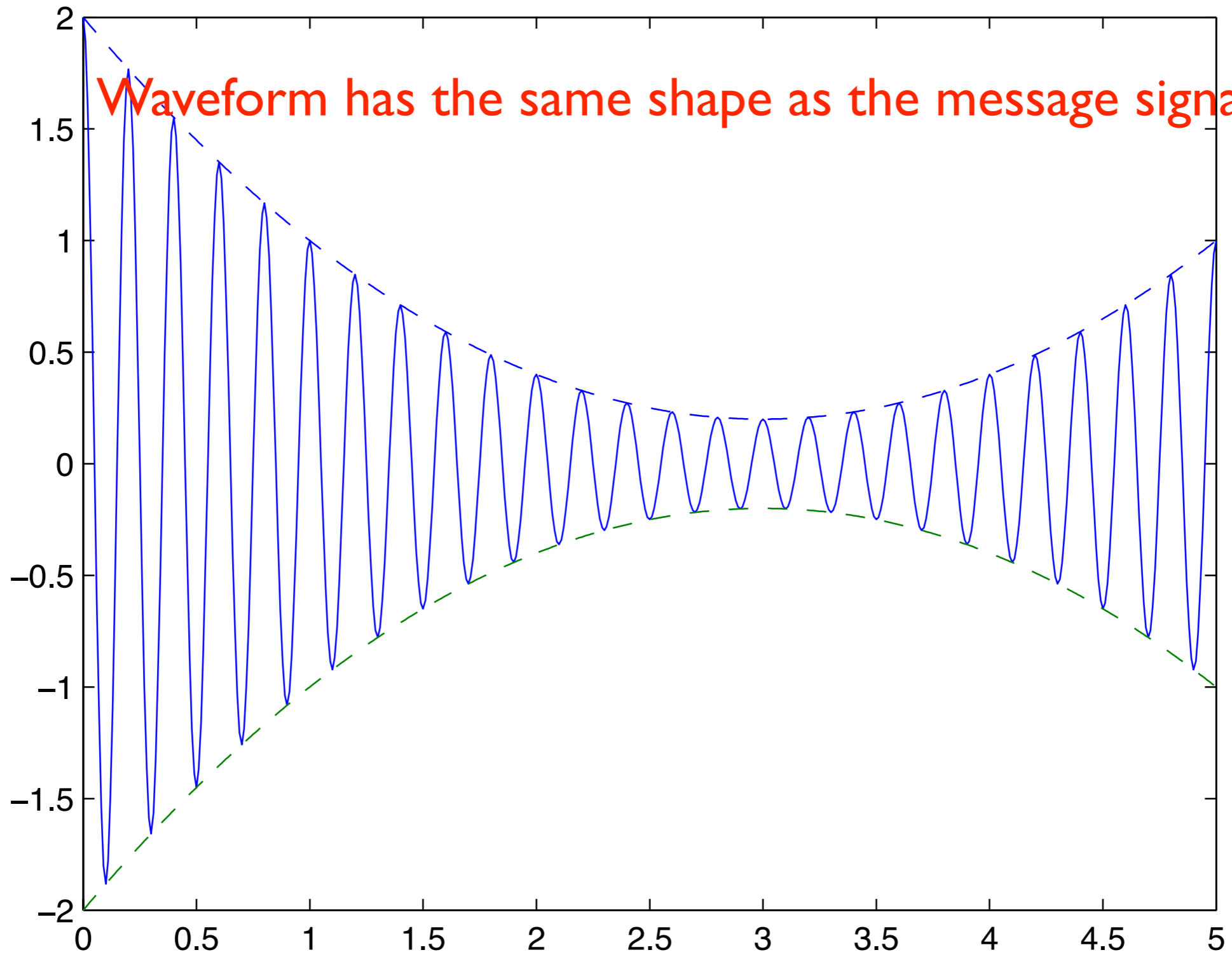

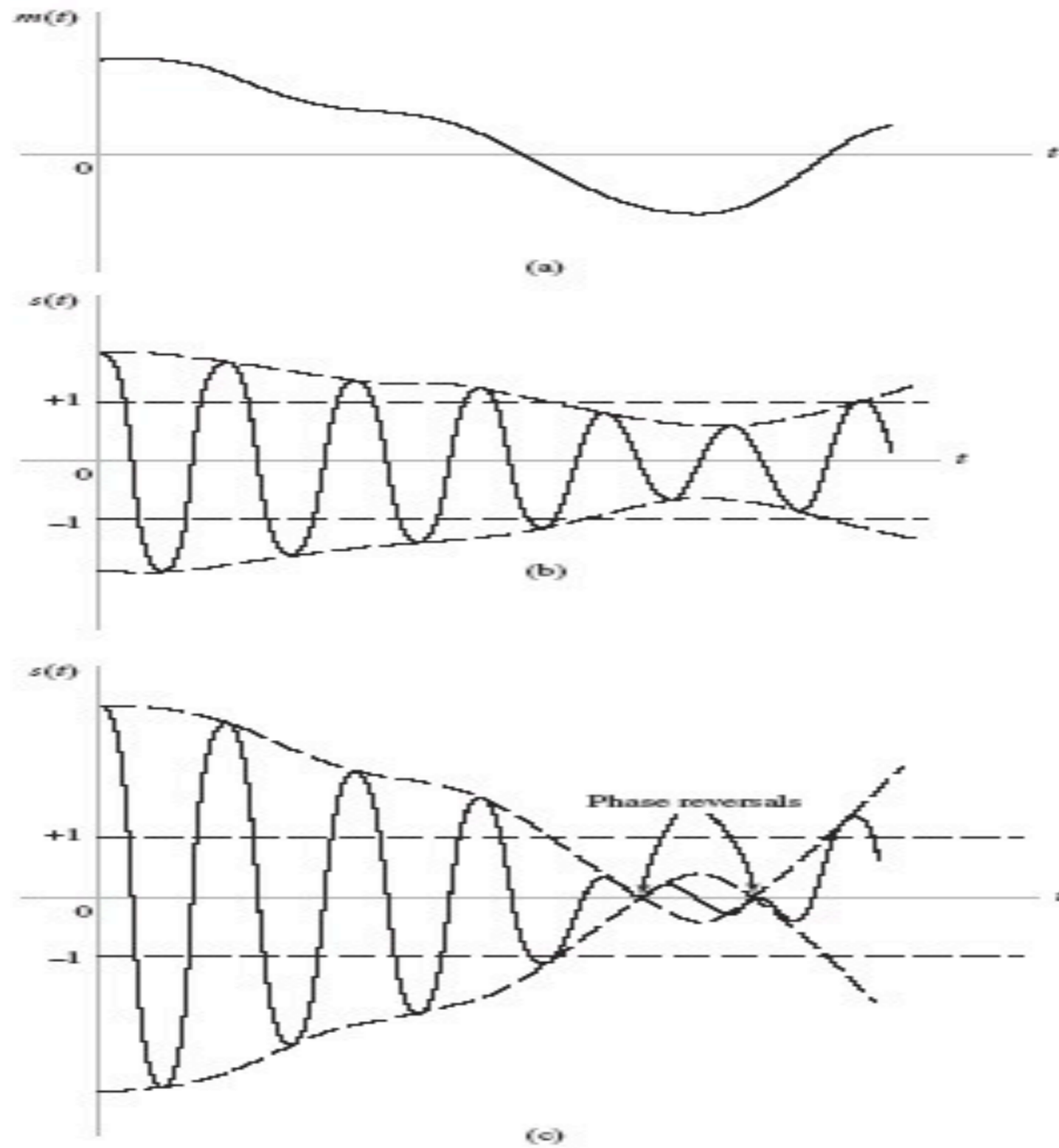
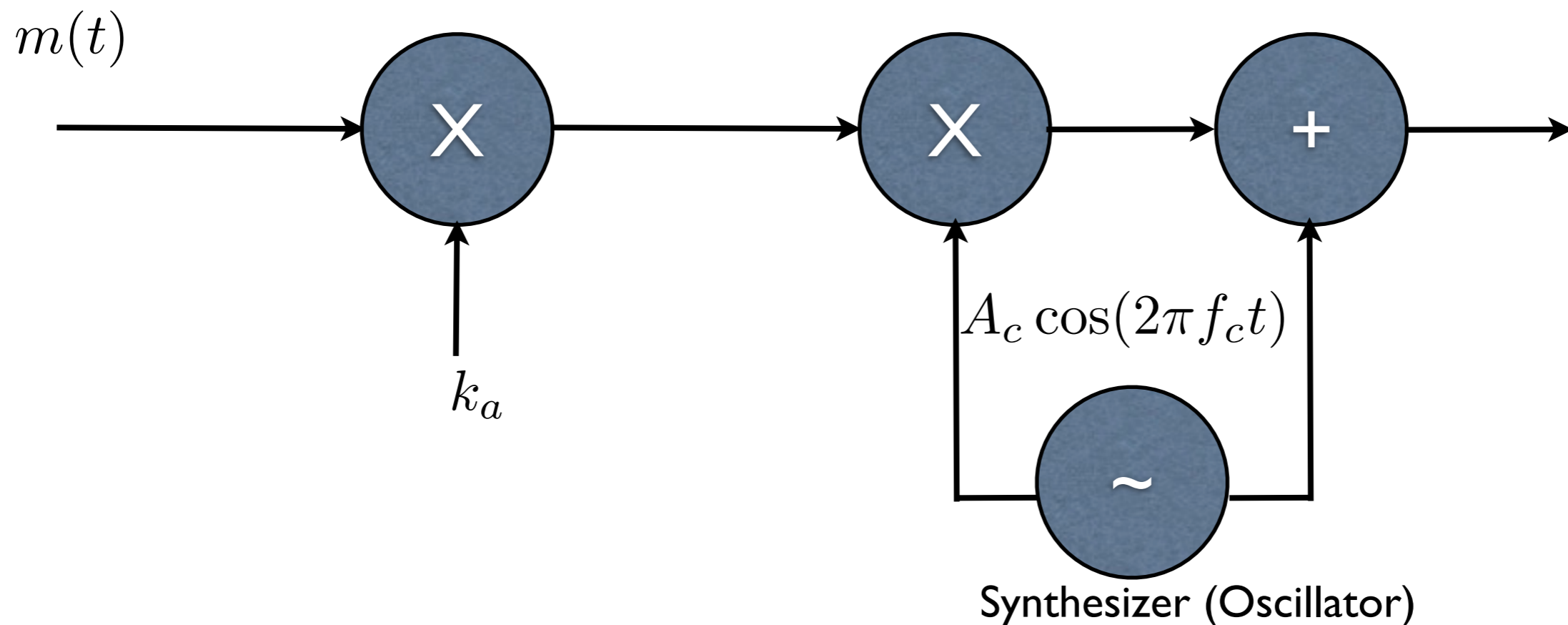

FIGURE 3.1 Illustration of the amplitude modulation process. (a) Message signal $m(t)$. (b) AM wave for $k_a m(t) < 1$ for all t . (c) AM wave for $|k_a m(t)| > 1$ for some t .

- If the amplification factor is considered, the amplitude modulated signal can be written as

$$s(t) = A_c [1 + k_a m(t)] c(t)$$

Note that A_c is just amplification factor.



- Envelop of $s(t)$ has essentially the same shape as the message signal $m(t)$ provided that two conditions are satisfied:

1. The amplitude of $k_a m(t)$ is always less than unity; that is

$$|k_a m(t)| < 1, \quad \text{for all } t$$

⊙ In this case, the function $1 + k_a m(t)$ is always positive !

2. The carrier frequency f_c is much greater than the highest frequency component W of the message signal $m(t)$ - that is,

$$f_c \gg W$$

We call W the **message bandwidth**.

Frequency-Domain Description of AM

- AM transmit signal

$$\begin{aligned} s(t) &= A_c [1 + k_a m(t)] \cos(2\pi f_c t) \\ &= A_c \cos(2\pi f_c t) + A_c k_a m(t) \cos(2\pi f_c t) \end{aligned}$$

- Fourier transform of AM transmitted signal

where we make use of

$$\mathcal{F}[\cos(2\pi f_c t)] = \frac{1}{2} [\delta(f - f_c) + \delta(f + f_c)]$$

Frequency-Domain Description of AM

- AM transmit signal

$$\begin{aligned} s(t) &= A_c [1 + k_a m(t)] \cos(2\pi f_c t) \\ &= A_c \cos(2\pi f_c t) + A_c k_a m(t) \cos(2\pi f_c t) \end{aligned}$$

- Fourier transform of AM transmitted signal

$$S(f) = \frac{A_c}{2} [\delta(f - f_c) + \delta(f + f_c)] + \frac{k_a A_c}{2} [M(f - f_c) + M(f + f_c)]$$

where we make use of

$$\mathcal{F}[\cos(2\pi f_c t)] = \frac{1}{2} [\delta(f - f_c) + \delta(f + f_c)]$$

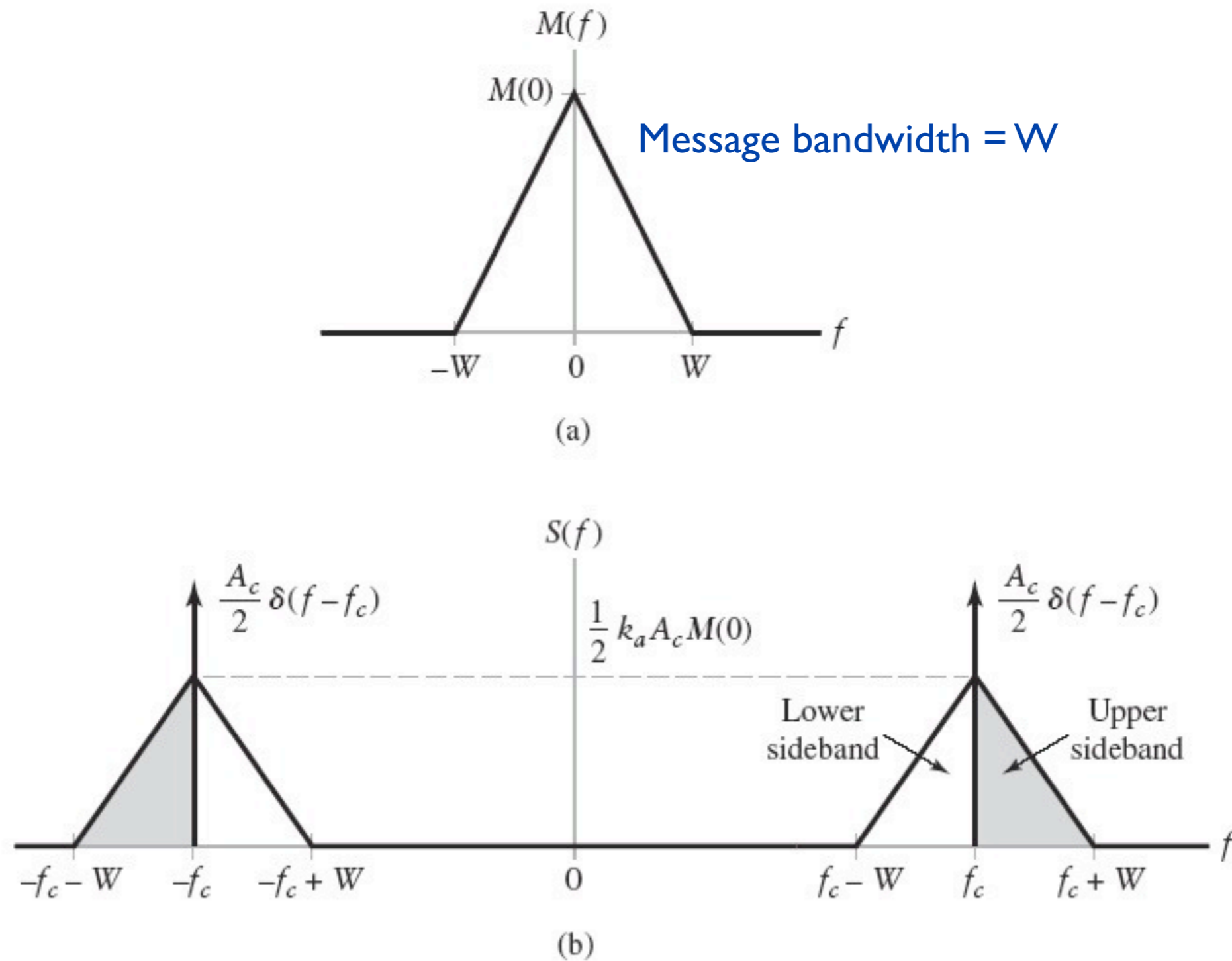
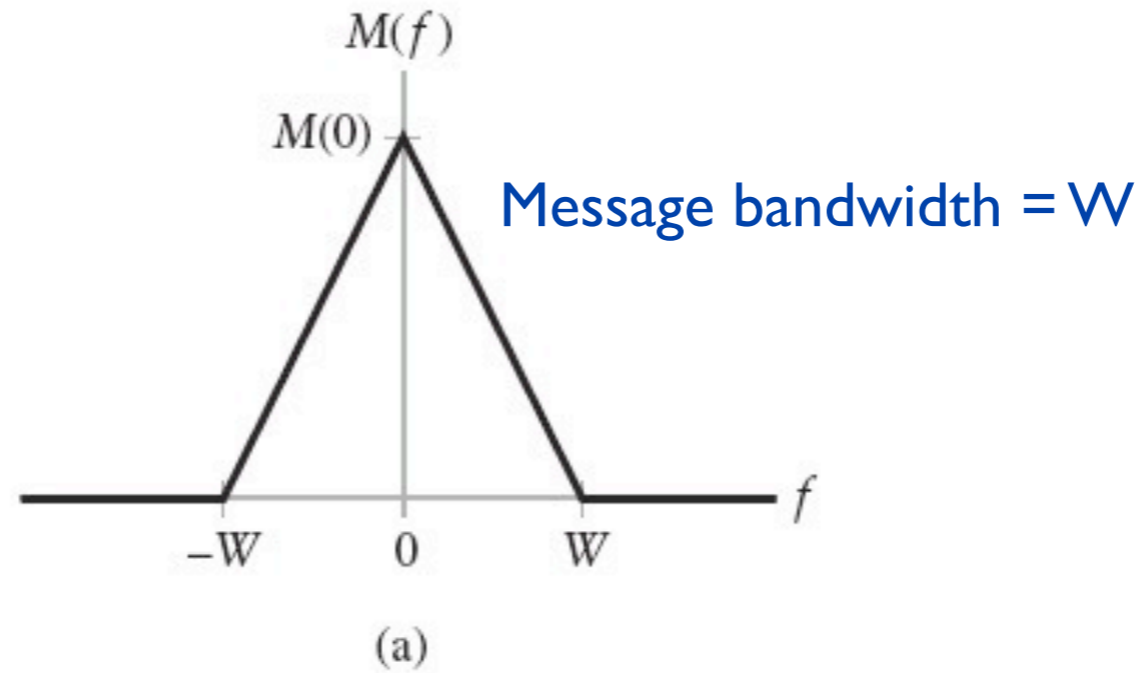

FIGURE 3.2 (a) Spectrum of message signal $m(t)$. (b) Spectrum of AM wave $s(t)$.



Transmission bandwidth: $B_T = 2W$

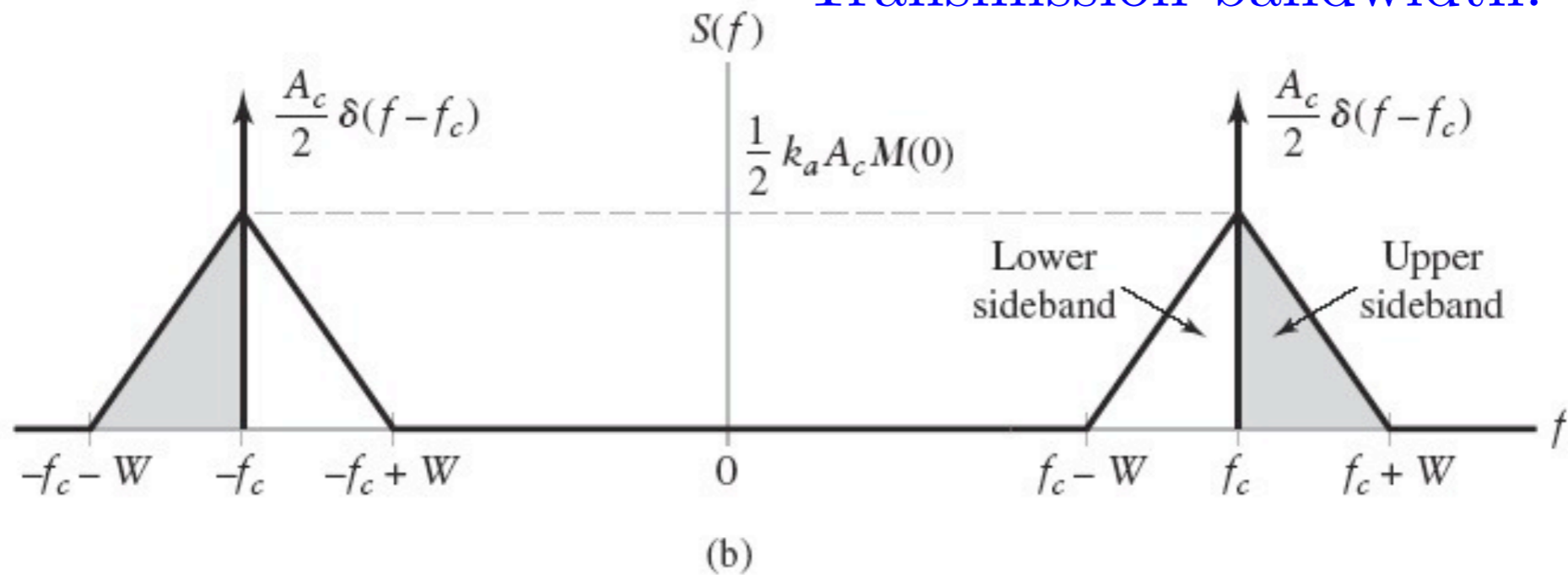
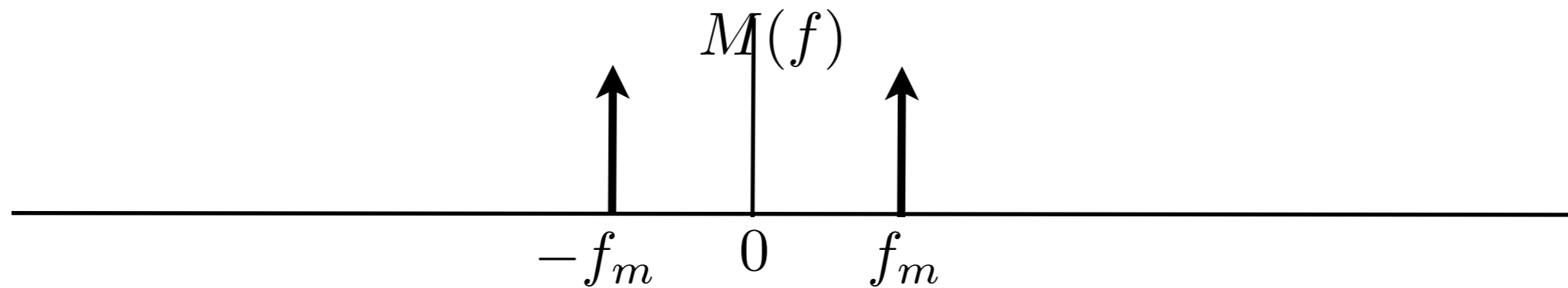

FIGURE 3.2 (a) Spectrum of message signal $m(t)$. (b) Spectrum of AM wave $s(t)$.

Single -Tone Modulation

- Consider single-tone modulating wave (message signal)

$$m(t) = A_m \cos(2\pi f_m t)$$



- carrier wave

$$c(t) = A_c \cos(2\pi f_c t)$$

Single -Tone Modulation

- Consider single-tone modulating wave (message signal)

$$m(t) = A_m \cos(2\pi f_m t)$$

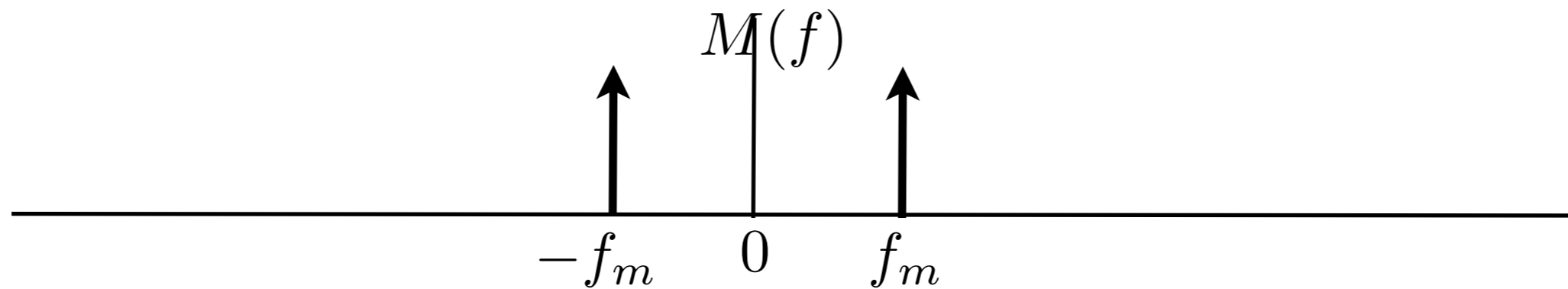

- carrier wave

$$c(t) = A_c \cos(2\pi f_c t)$$

Single -Tone Modulation

- Consider single-tone modulating wave (message signal)

$$m(t) = A_m \cos(2\pi f_m t)$$

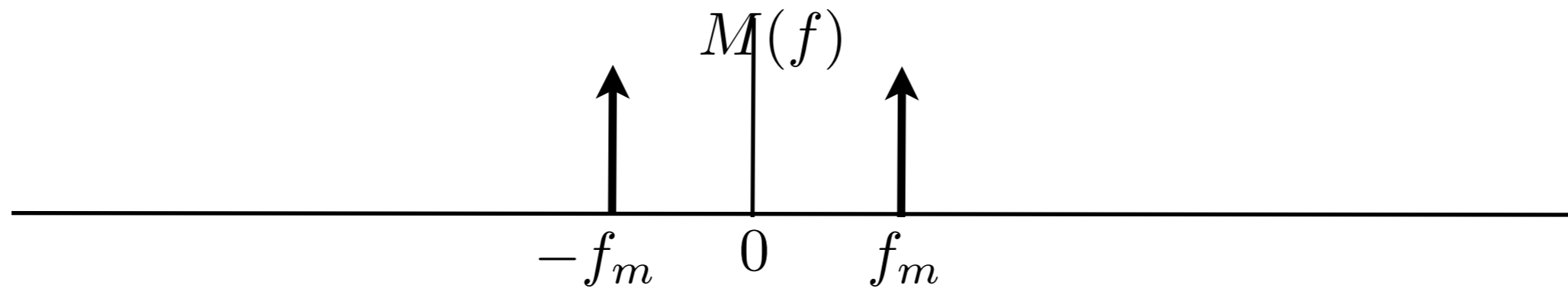

- carrier wave

$$c(t) = A_c \cos(2\pi f_c t)$$

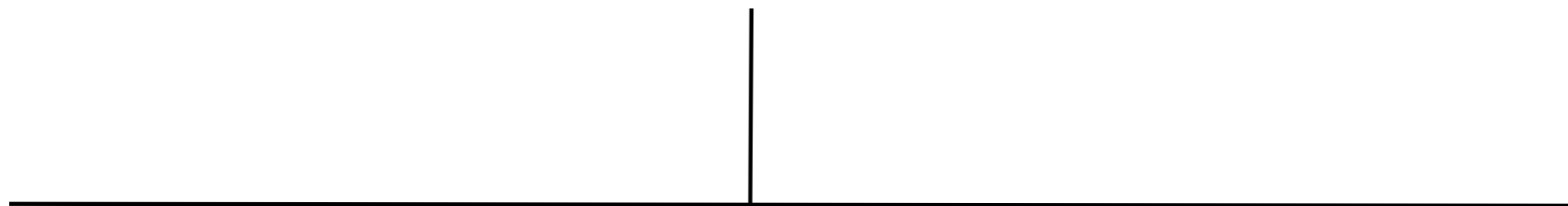

Single -Tone Modulation

- Consider single-tone modulating wave (message signal)

$$m(t) = A_m \cos(2\pi f_m t)$$

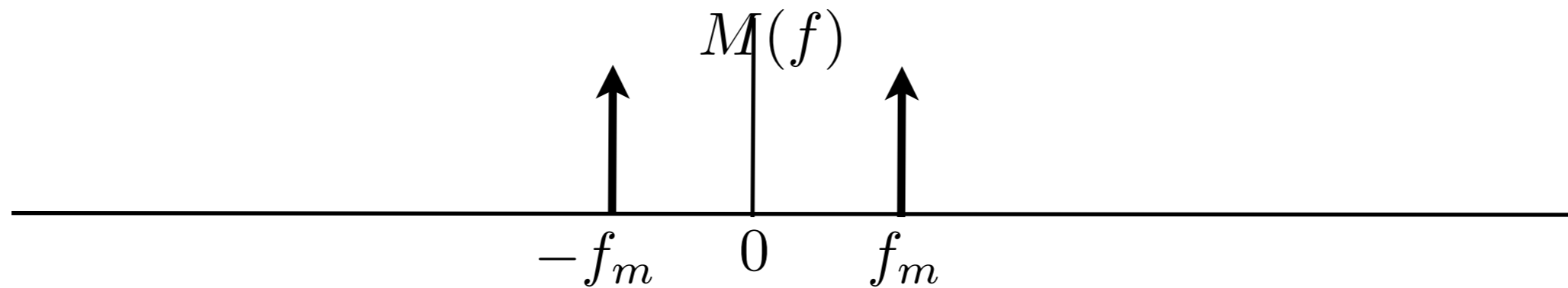

- carrier wave

$$c(t) = A_c \cos(2\pi f_c t)$$

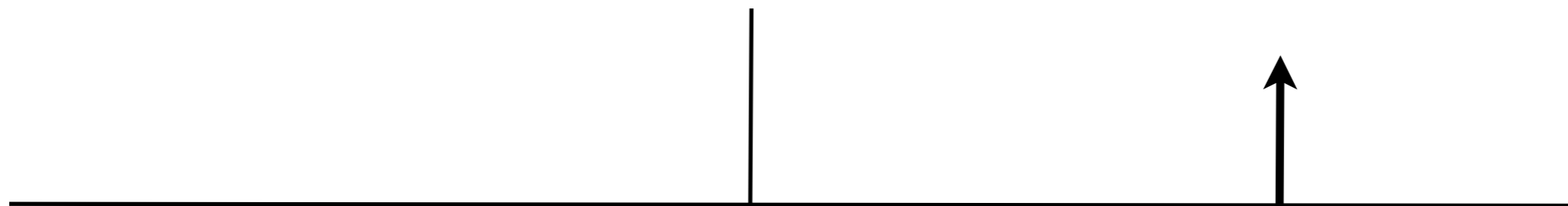

Single -Tone Modulation

- Consider single-tone modulating wave (message signal)

$$m(t) = A_m \cos(2\pi f_m t)$$

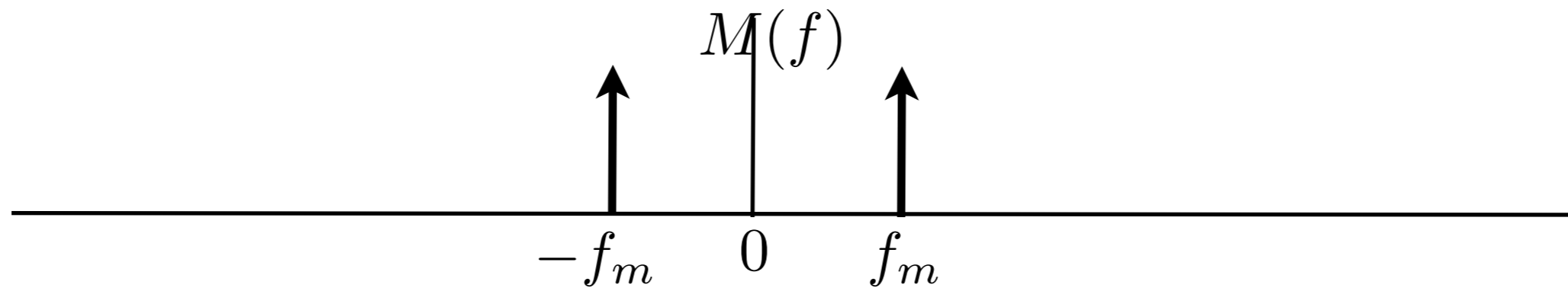

- carrier wave

$$c(t) = A_c \cos(2\pi f_c t)$$

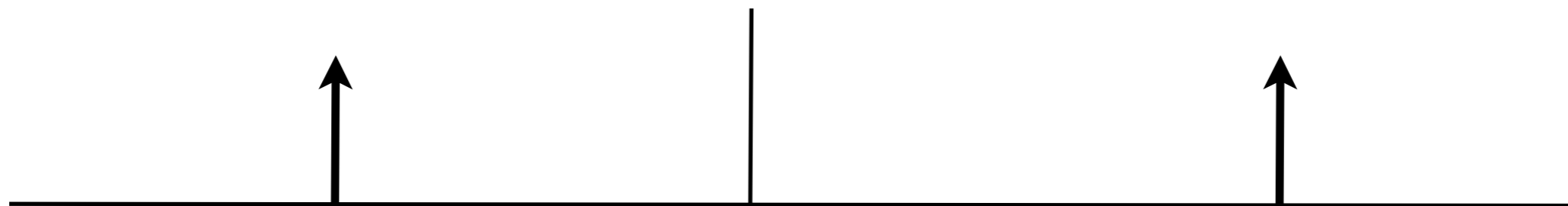

Single -Tone Modulation

- Consider single-tone modulating wave (message signal)

$$m(t) = A_m \cos(2\pi f_m t)$$

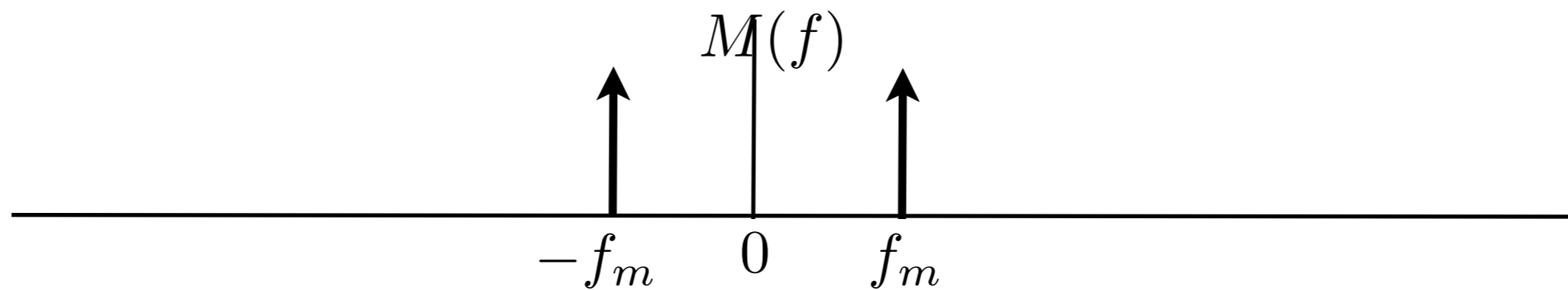

- carrier wave

$$c(t) = A_c \cos(2\pi f_c t)$$

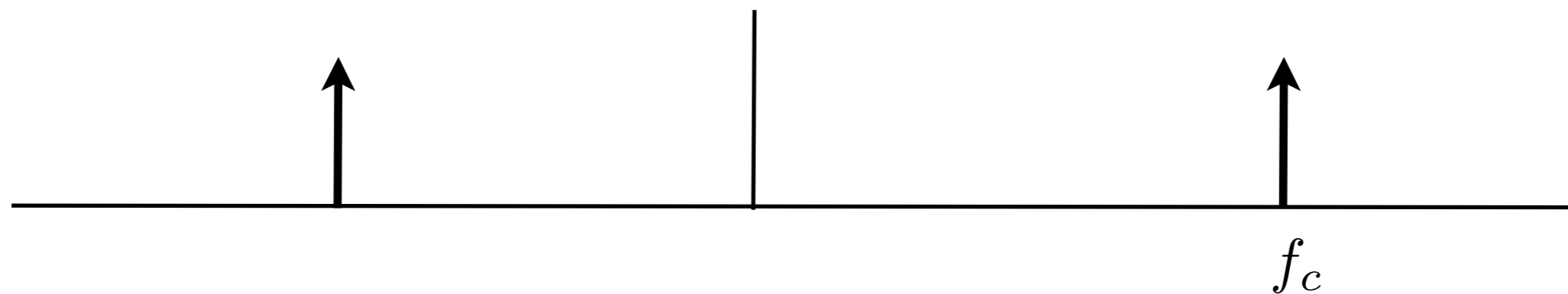

Single -Tone Modulation

- Consider single-tone modulating wave (message signal)

$$m(t) = A_m \cos(2\pi f_m t)$$

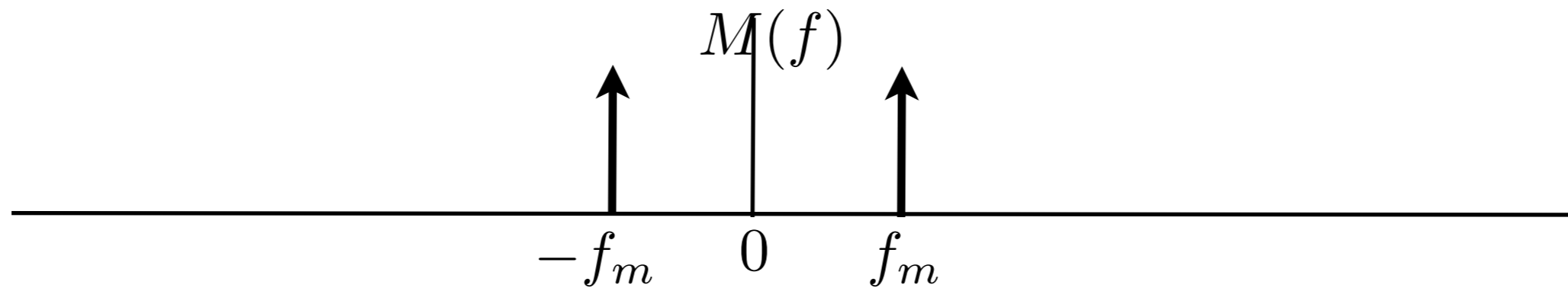

- carrier wave

$$c(t) = A_c \cos(2\pi f_c t)$$

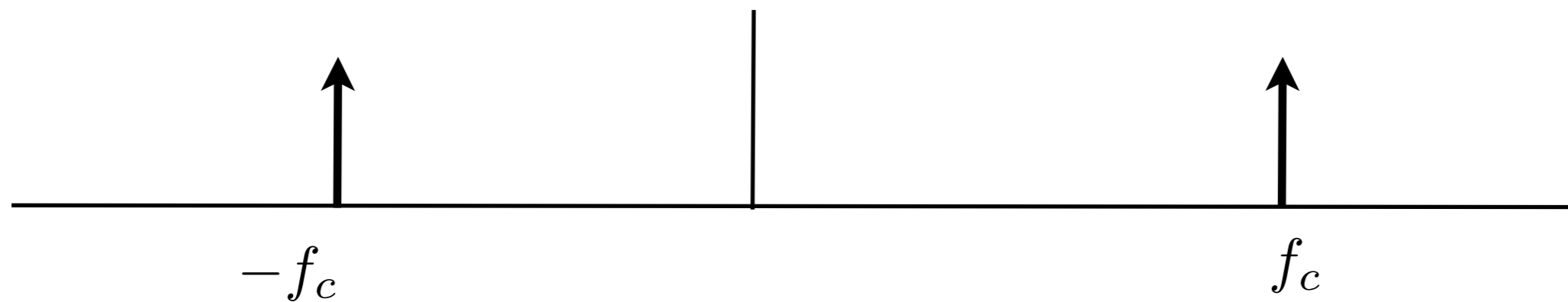

Single -Tone Modulation

- Consider single-tone modulating wave (message signal)

$$m(t) = A_m \cos(2\pi f_m t)$$

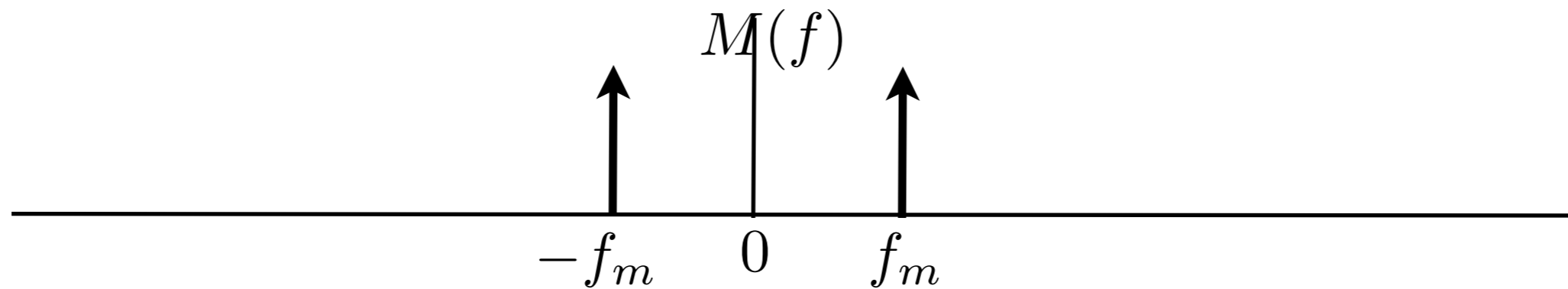

- carrier wave

$$c(t) = A_c \cos(2\pi f_c t)$$

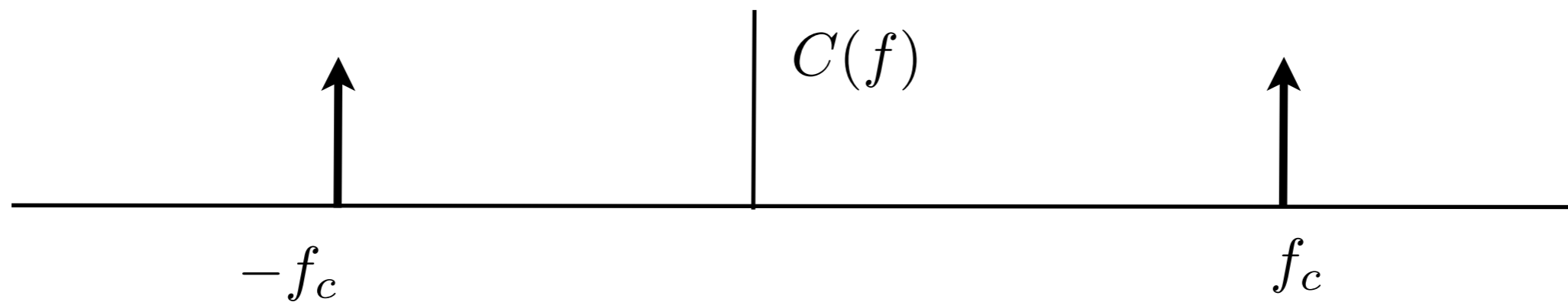

- AM wave

$$s(t) = A_c [1 + \mu \cos(2\pi f_m t)] \cos(2\pi f_c t)$$

where $\mu = k_a A_m$

- Maximum envelope value and Minimum envelope value

$$A_{\max} = A_c(1 + \mu), \quad A_{\min} = A_c(1 - \mu)$$

- Ratio between the max and min values

$$\frac{A_{\max}}{A_{\min}} = \frac{A_c(1 + \mu)}{A_c(1 - \mu)} \quad \Longrightarrow \quad \mu = \frac{A_{\max} - A_{\min}}{A_{\max} + A_{\min}}$$

- Fourier transform

$$s(t) = A_c \cos(2\pi f_c t) + \frac{1}{2}\mu A_c \cos[2\pi(f_c + f_m)t] + \frac{1}{2}\mu A_c \cos[2\pi(f_c - f_m)t]$$

$$S(f) = \frac{1}{2}A_c [\delta(f - f_c) + \delta(f + f_c)]$$

$$+ \frac{1}{4}\mu A_c [\delta(f - f_c - f_m) + \delta(f + f_c + f_m)]$$

$$+ \frac{1}{4}\mu A_c [\delta(f - f_c + f_m) + \delta(f + f_c - f_m)]$$

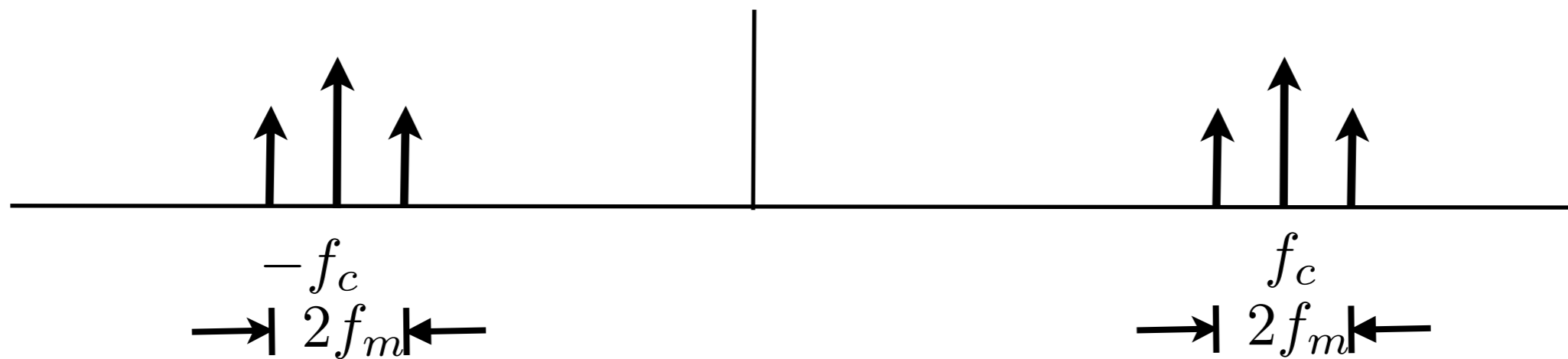

- Recall the single-tone modulated signal

$$s(t) = A_c \cos(2\pi f_c t) + \frac{1}{2} A_c \mu \cos[2\pi(f_c + f_m)t] + \frac{1}{2} A_c \mu \cos[2\pi(f_c - f_m)t]$$

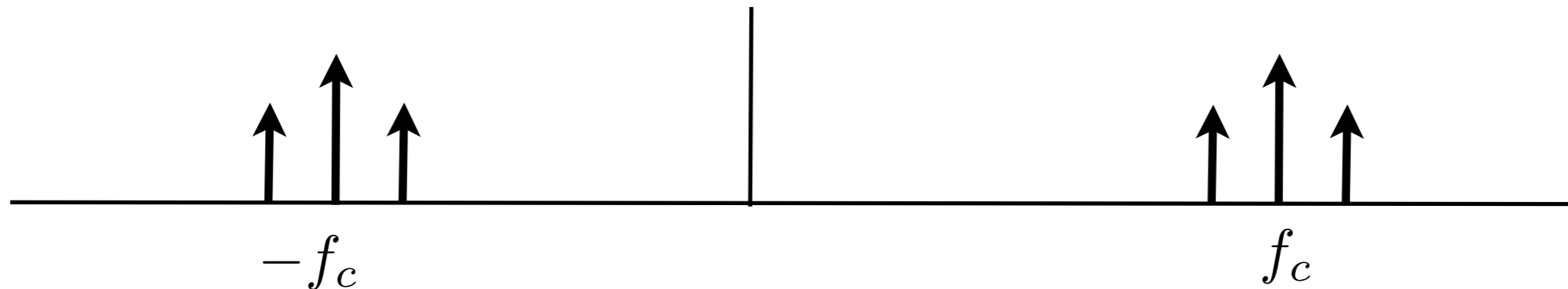

- Power calculation

- Carrier power = $\frac{1}{2} A_c^2$

- Upper-side-frequency power = $\frac{1}{8} \mu^2 A_c^2$

- Lower-side-frequency power = $\frac{1}{8} \mu^2 A_c^2$

- Power ratio

- Total power = $\frac{1}{2}A_c^2 + \frac{1}{8}\mu^2 A_c^2 + \frac{1}{8}\mu^2 A_c^2 = 0.25 (2 + \mu^2) A_c^2$

- Power portion of carrier signal

$$\frac{\text{Carrier power}}{\text{Total power}} = \frac{2}{2 + \mu^2}$$

- Power portion of message signal

$$\frac{\text{Uppersideband+Lowersideband}}{\text{Total power}} = \frac{\mu^2}{2 + \mu^2}$$

- If $\mu = 1$, only 1/3 out of total power is allocated to the message signal.

Envelope Detector

- The narrowband message signal modulated by AM can be recovered at the receiver by a simple envelope detector circuit

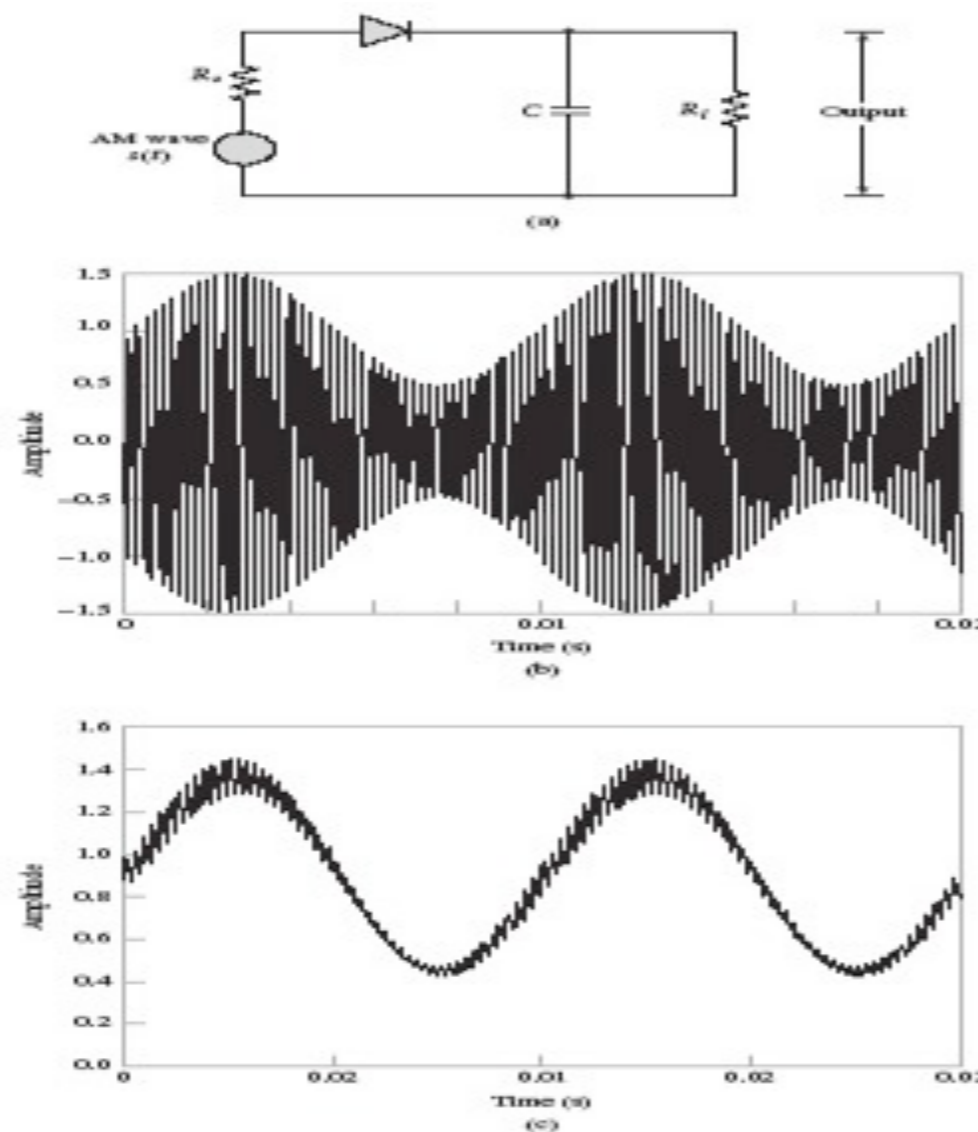

$$\frac{1}{f_c} \ll R_L C \ll \frac{1}{W}$$

FIGURE 3.9 Envelope detector. (a) Circuit diagram. (b) AM wave input. (c) Envelope detector output

[Ref: Haykin & Moher, Textbook]