

# Copyright statement

- The images and the pictures in this lecture are provided by the CDs accompanied by the books
  1. University Physics, Bauer and Westfall, McGraw-Hill, 2011.
  2. Principles of Physics, Halliday, Resnick, and Walker, Wiley, 8<sup>th</sup> and 9<sup>th</sup> Ed.
- The rest is made by me.

# Maxwell's equations

## Maxwell's Equations<sup>a</sup>

Name	Equation	
Gauss' law for electricity	$\oint \vec{E} \cdot d\vec{A} = q_{\text{enc}}/\epsilon_0$	Relates net electric flux to net enclosed electric charge
Gauss' law for magnetism	$\oint \vec{B} \cdot d\vec{A} = 0$	Relates net magnetic flux to net enclosed magnetic charge
Faraday's law	$\oint \vec{E} \cdot d\vec{s} = -\frac{d\Phi_B}{dt}$	Relates induced electric field to changing magnetic flux
Ampere–Maxwell law	$\oint \vec{B} \cdot d\vec{s} = \mu_0\epsilon_0 \frac{d\Phi_E}{dt} + \mu_0 i_{\text{enc}}$	Relates induced magnetic field to changing electric flux and to current

<sup>a</sup>Written on the assumption that no dielectric or magnetic materials are present.

# Magnetism and electrons

## Orbital magnetic dipole moment

$$\mu_{\text{orb}} = iA$$

$$i = \frac{e}{2\pi r/v}, \quad A = \pi r^2$$

$$\mu_{\text{orb}} = \frac{e}{2\pi r/v} \pi r^2 = \frac{evr}{2} = \frac{1}{2m} L_{\text{orb}}$$

$$\vec{\mu}_{\text{orb}} = -\frac{e}{2m} \vec{L}_{\text{orb}}$$

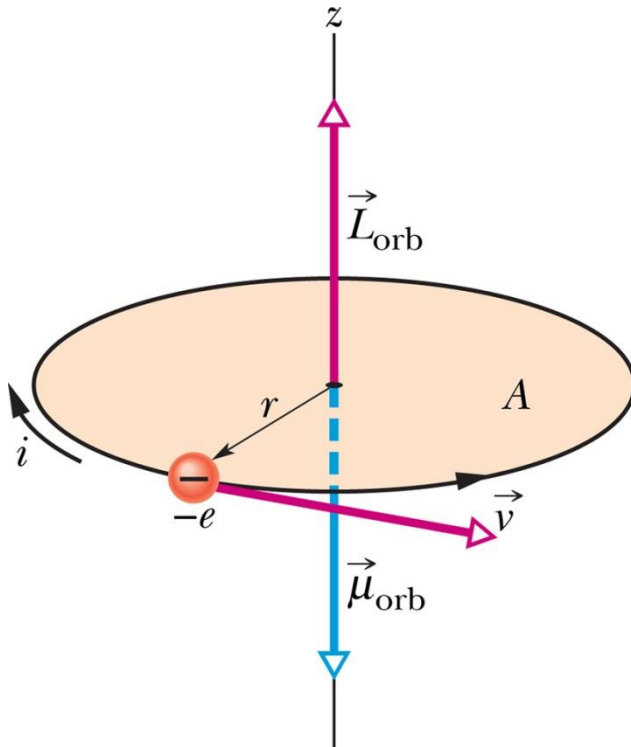

# Non-uniform magnetic field

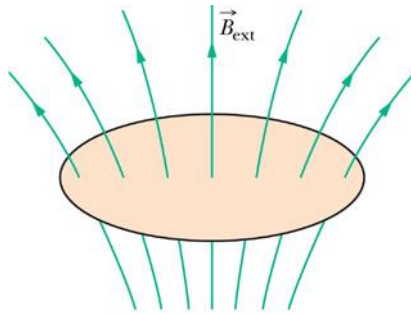

(a)

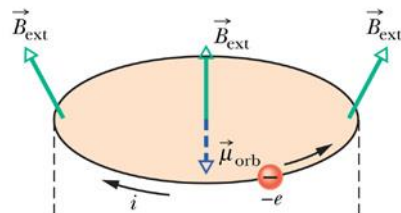

(b)



(c)

$$d\vec{F} = id\vec{L} \times \vec{B}_{\text{ext}}$$

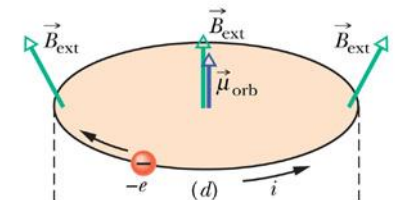

(d)



(e)

Spin magnetic dipole moment  $\vec{\mu}_s = -\frac{e}{m}\vec{S}$

$$S_z = m_s \frac{h}{2\pi}, \quad (m_s = \pm \frac{1}{2})$$

$h = 6.63 \times 10^{-34} \text{ J} \cdot \text{s}$  Planck constant

$$\mu_{s,z} = \pm \frac{eh}{4\pi m}$$

$$\mu_B = \frac{eh}{4\pi m} = 9.27 \times 10^{-27} \text{ J/T} \quad (\text{Bohr magneton})$$

$$U = -\vec{\mu}_s \cdot \vec{B}_{\text{ext}} = -\mu_{s,z} B_{\text{ext}}$$

$$\vec{\mu}_{\text{orb}} = -\frac{e}{2m}\vec{L}_{\text{orb}} \quad L_{\text{orb},z} = m_l \frac{h}{2\pi}, \quad m_l = 0, \pm 1, \pm 2, \dots$$

$$\mu_{\text{orb},z} = -m_l \frac{eh}{4\pi m} = -m_l \mu_B \quad U = -\vec{\mu}_{\text{orb}} \cdot \vec{B}_{\text{ext}}$$

# Magnetic material

- diamagnetism: induced magnetic dipole moment in external magnetic field
- paramagnetism: permanent magnetic dipole moments distributed randomly
- ferromagnetism: permanent magnetic dipole moment aligned in one direction

# Magnetic properties

paramagnetic

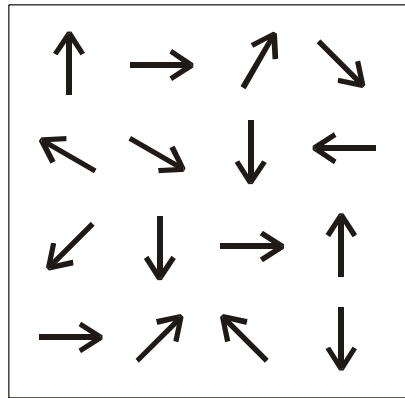

a

ferromagnetic

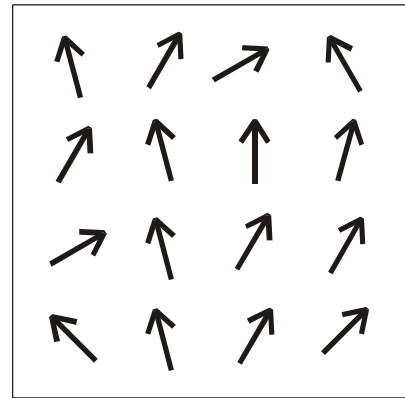

b

antiferromagnetic

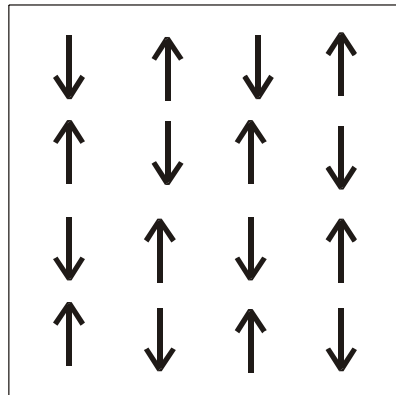

c

준강자성

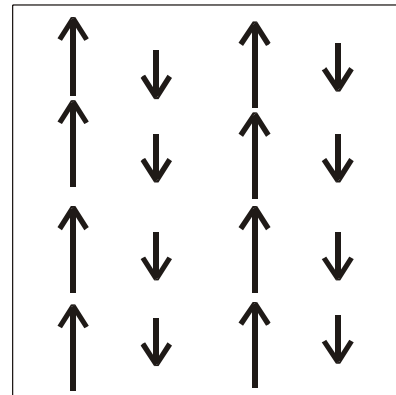

d

# 물질의 자기적 성질: ferromagnetism



In bulk material the domains usually cancel, leaving the material unmagnetized.

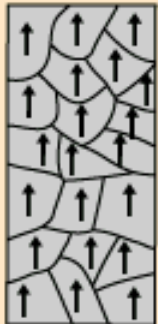

Externally applied magnetic field.

Iron will become magnetized in the direction of any applied magnetic field. This magnetization will produce a magnetic pole in the iron opposite to that pole which is nearest to it, so the iron will be attracted to either pole of a magnet.

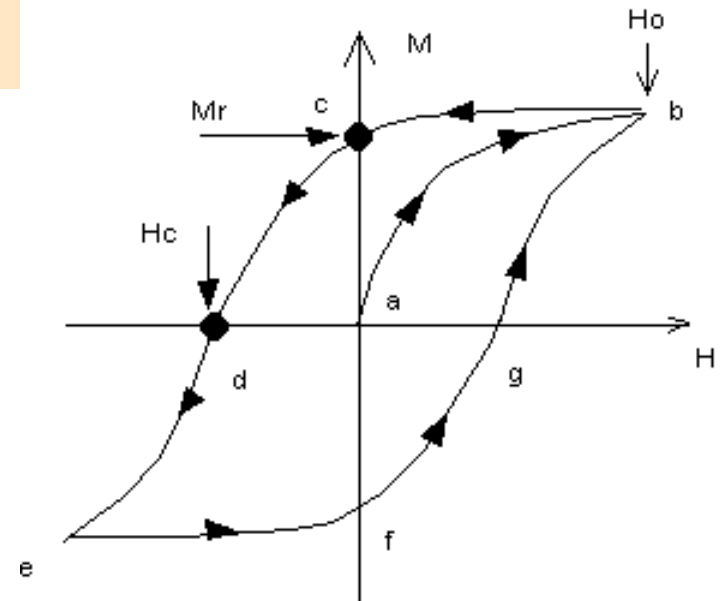
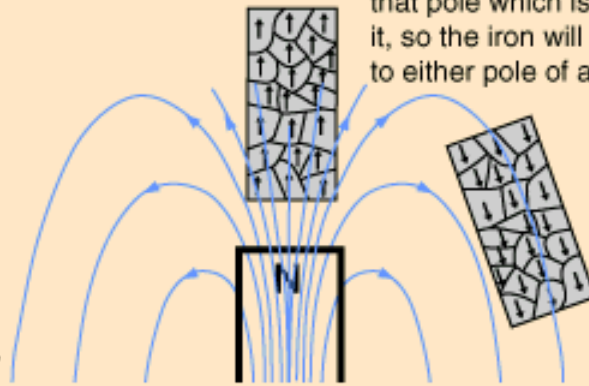



# Maxwell's equations

$$\oint \mathbf{E} \cdot d\mathbf{A} = \frac{q}{\epsilon_0}$$

$$\oint \mathbf{B} \cdot d\mathbf{A} = 0$$

$$\oint \mathbf{E} \cdot d\mathbf{s} = -\frac{d\Phi_B}{dt}$$

$$\oint \mathbf{B} \cdot d\mathbf{s} = \mu_0 i + \mu_0 \epsilon_0 \frac{d\Phi_E}{dt}$$



Electromagnetic wave  
equation

$$E(t) = E_m \sin(kx - \omega t)$$

$$B(t) = B_m \sin(kx - \omega t)$$

Electromagnetic waves  $\rightarrow$  light

$$c = \frac{\omega}{k} = \frac{1}{\sqrt{\mu_0 \epsilon_0}}$$

# Spectrum of EM waves

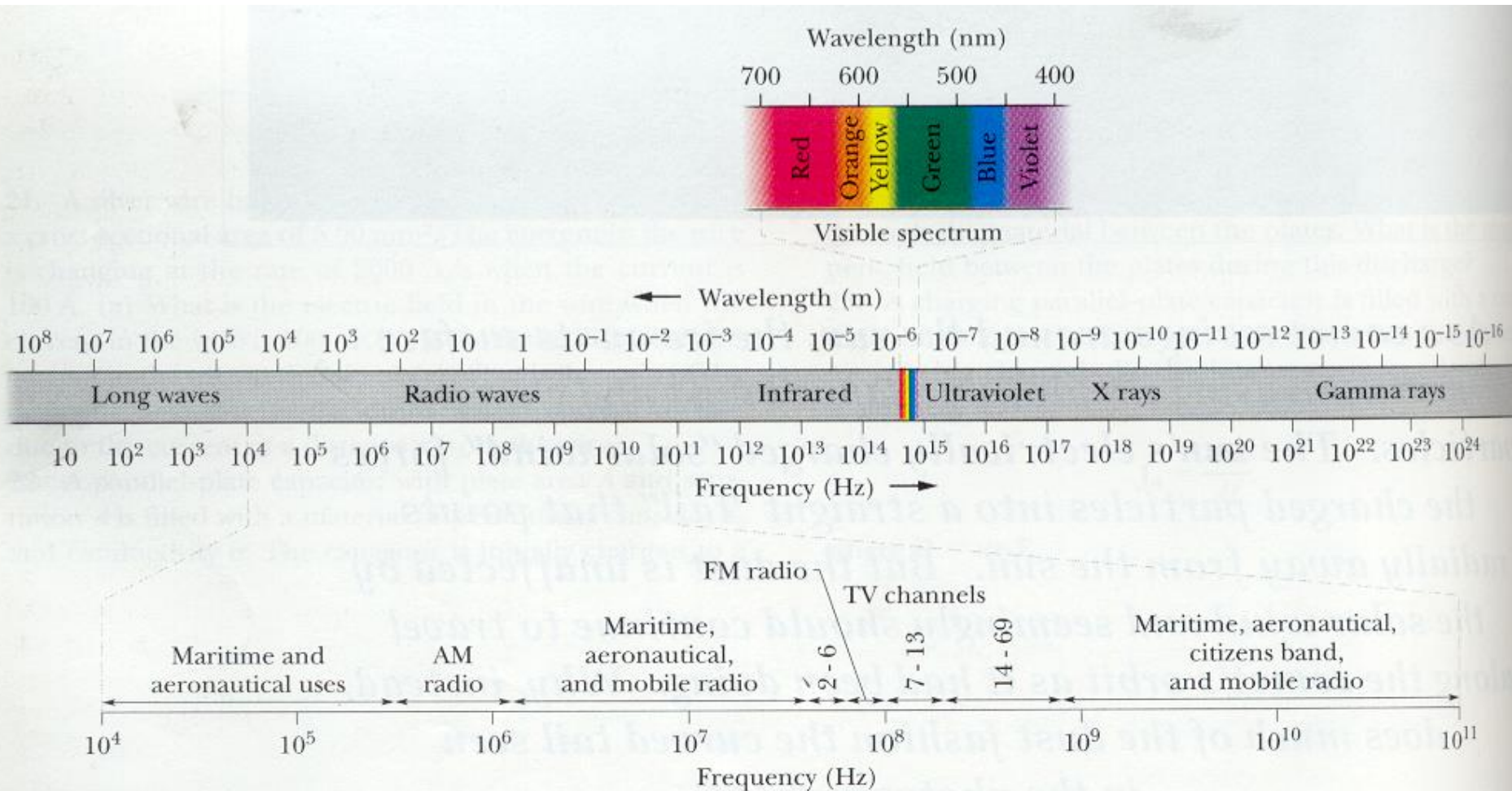

# Velocity of EM waves in vacuum

$$c = \frac{\omega}{k} = \frac{1}{\sqrt{\mu_0 \epsilon_0}}$$

1) It is defined as  $c = 299,792,458$  m/sec.

(근사적으로 초속 30만 km)

2)  $c$  is the same independent of frequency.

Cf). 프리즘에서의 광선의 분산현상

3)  $c$  is independent of the frames of the observer.

cf). 달리는 기차를 쫓아가며 관측한 기차의 속도

# Properties of EM waves

1. The EM fields oscillate orthogonal to the propagation. (transverse wave)
2. Electric fields are orthogonal to magnetic fields
3.  $\mathbf{E} \times \mathbf{B}$  is the direction of the EM waves.
4. EM fields oscillate with the same frequency and the same phase.

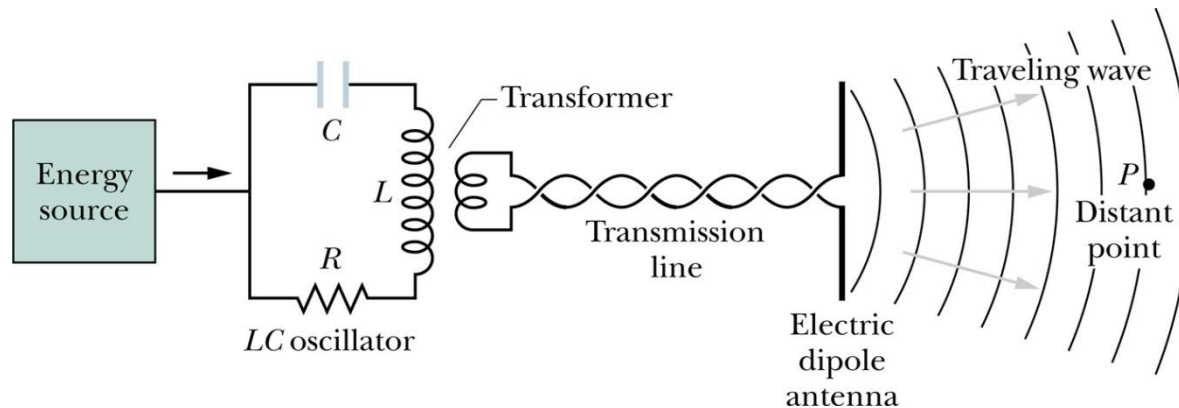

# Picture of propagating EM waves

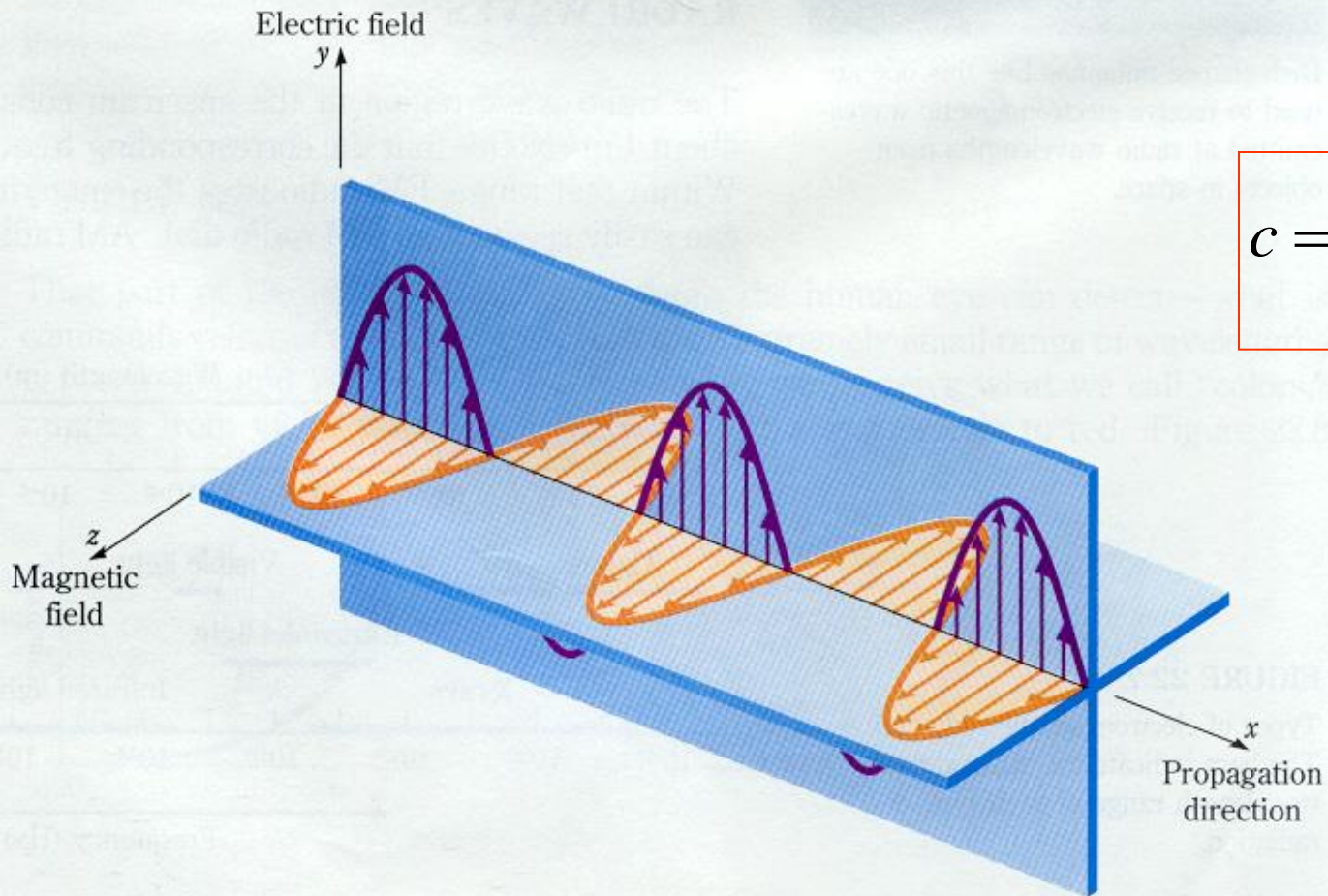

$$c = \frac{\omega}{k} = \frac{1}{\sqrt{\mu_0 \epsilon_0}}$$

$$E = E_m \sin(kx - \omega t), \quad B = B_m \sin(kx - \omega t)$$

# EM wave and Maxwell eq. : wave equation

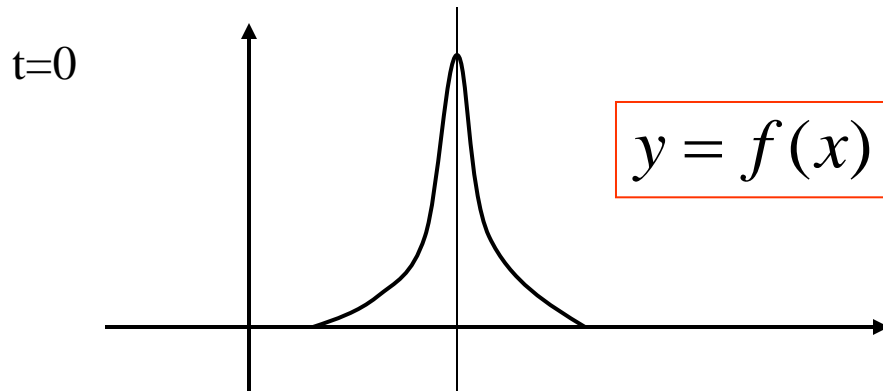

$$y(x, t) = f(x - vt)$$

$$\frac{\partial^2 y}{\partial x^2} - \frac{1}{v^2} \frac{\partial^2 y}{\partial t^2} = 0$$

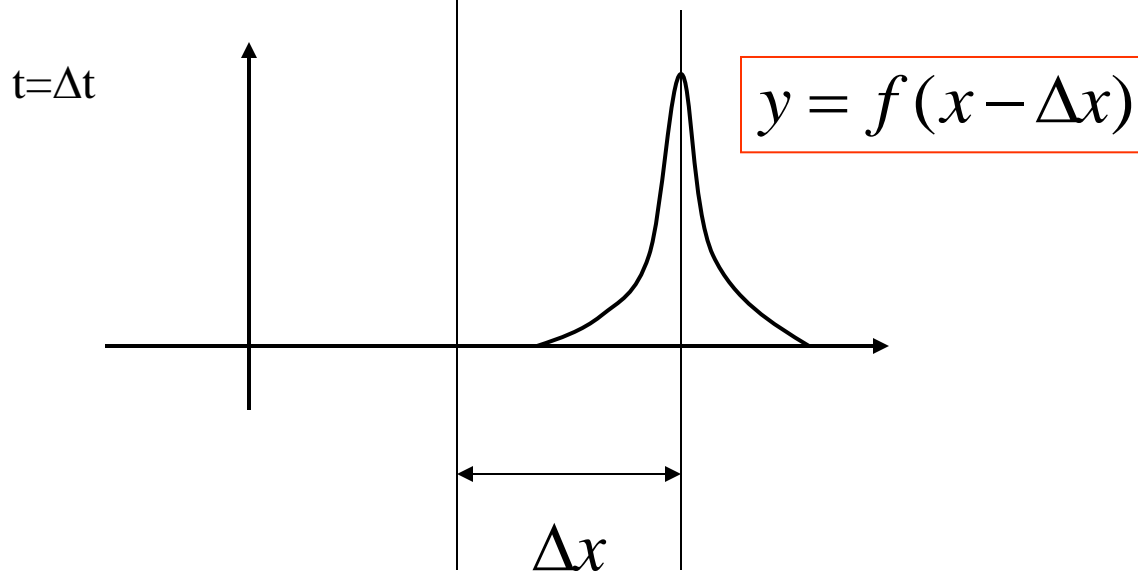

$$y(x, t) = y_m \sin(kx - \omega t)$$

# Electromagnetic wave and Maxwell's equations

$$\frac{\partial^2 E(x,t)}{\partial x^2} - \frac{1}{c^2} \frac{\partial^2 E(x,t)}{\partial t^2} = 0$$

$$\frac{\partial^2 B(x,t)}{\partial x^2} - \frac{1}{c^2} \frac{\partial^2 B(x,t)}{\partial t^2} = 0$$

$$E(x,t) = E_m \sin(kx - \omega t)$$

$$B(x,t) = B_m \sin(kx - \omega t)$$

# EM waves and Maxwell's equations

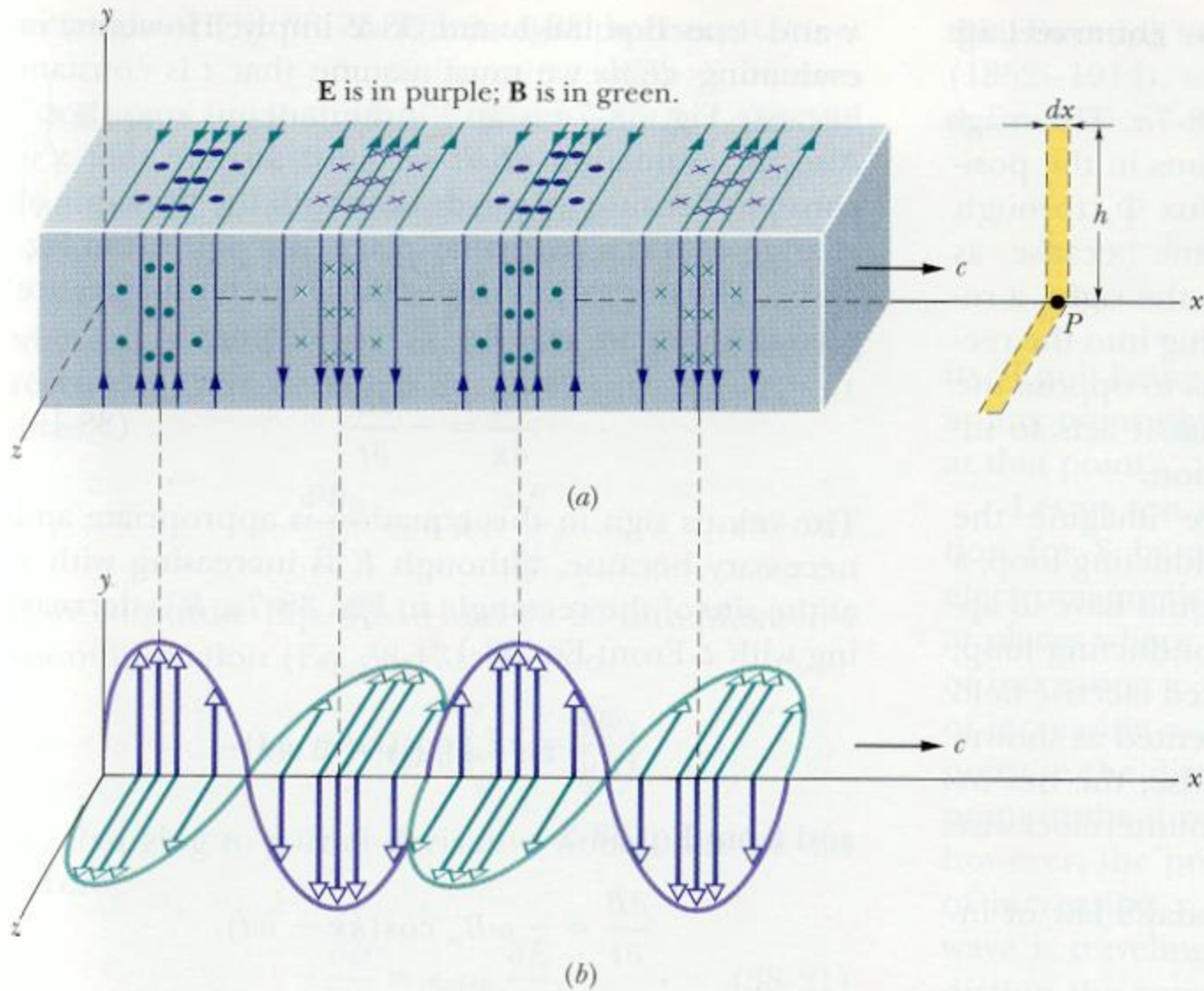



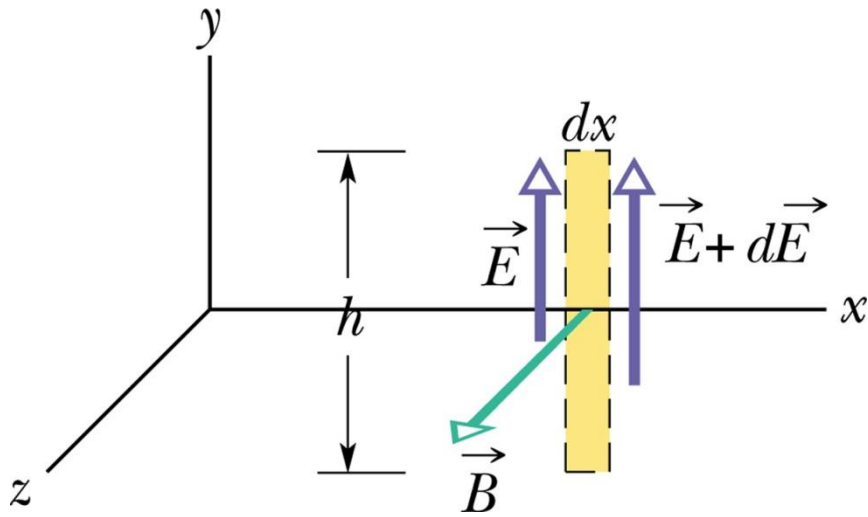

Faraday's law

$$\oint \vec{E} \cdot d\vec{s} = -\frac{d\Phi_B}{dt}$$

$$\oint \vec{E} \cdot d\vec{s} = (E + dE)h - Eh = hdE \quad hdE = -hdx \frac{dB}{dt}$$

$$\Phi_B = Bhdx \rightarrow \frac{d\Phi_B}{dt} = hdx \frac{dB}{dt} \quad \frac{dE}{dx} = -\frac{dB}{dt}$$

$$\frac{\partial E}{\partial x} = -\frac{\partial B}{\partial t}$$

$$\frac{\partial E}{\partial x} = kE_m \cos(kx - \omega t)$$

$$\frac{\partial B}{\partial t} = -\omega B_m \cos(kx - \omega t)$$

$$\rightarrow \frac{E_m}{B_m} = \frac{\omega}{k} = c$$